

**.mdd**

**Panele i blendy**

v5.1 / 07.07.2023

Sonic - panele biurkowe	2
Twin - panele biurkowe	14
Sonic - panele wolnostojące	25
Viva - panel wolnostojący	30
Sonic - panele ścienne i sufitowe	33
Bazalto - panele ścienne	39
Mix - panele ścienne i sufitowe	41
Oslony przednie do biurka	47

Zestawienie kolorystyczne - Sonic - panele biurkowe

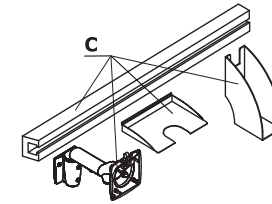
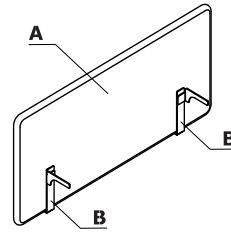
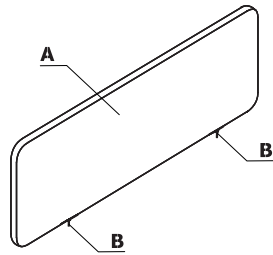

Materiał	Kolor	Panele														
		A - Panel	B - Uchwyt	C - Akcesoria												
Tkanina	Nemo	✓														
	Runner	II grupa														
	Medley	II grupa														
	**Atlantic	II grupa														
	Vita	II grupa														
	Mica	II grupa														
	Go Check	II grupa														
	****Charles	II grupa														
	*Tkanina powierzona	II grupa														
	Synergy	III grupa														
	***Silvertex	III grupa														
	Tessa	III grupa														
	Oceanic	III grupa														
	Quest	III grupa														
	Grain	III grupa														
	Atlas	IV grupa														

\* Zastosowanie tkaniny powierzonej wymaga przeprowadzenia prób tapicerskich, w celu sprawdzenia możliwości wykonawczych

\*\* Istnieje możliwość zamówienia produktu w pełnej kolorystyce Atlantic wg wzornika Gabriel w terminie nie krótszym niż 7 tygodni

\*\*\* Istnieje możliwość zamówienia produktu w pełnej kolorystyce Silvertex wg wzornika Spradling w terminie nie krótszym niż 15 dni roboczych

\*\*\*\* Istnieje możliwość zamówienia produktu w pełnej kolorystyce Charles wg wzornika Dekoma w standardowym terminie realizacji.

Materiał	Kolor	Panele													
		A - Panel	B - Uchwyt	C - Akcesoria											
Metal	M009 - aluminium półmat RAL 9006		✓	✓											
	M015 - biały półmat RAL 9010		✓												
	M115 - czarny półmat RAL 9005		✓												
	M154 - antracyt półmat RAL 7043		✓												



## Nabiurkowe - do biurek pojedynczych i biurek typu bench

- 1 Panel Sonic** - tapicerowany, klasa akustyczności "A", możliwość wpinania szpilek
- 2 Zamek błyskawiczny** - ozdobny, bez możliwości odpinania, kolor: grafit
- 3 Rama** - konstrukcja z litego drewna klejonego
- 4 Wypełnienie** - włóknina akustyczna o wysokim stopniu pochłaniania i rozpraszania dźwięków
- 5 Wspornik stalowy** - osadzony w ramie, z gwintem maszynowym do stabilnego mocowania uchwyty paneli (dotyczy paneli nabiurkowych)

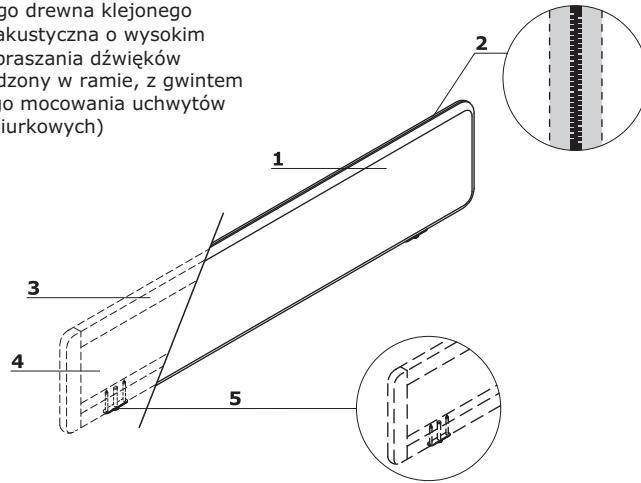

## Uchwyt do Ogi Drive - wymiary (mm)

- 1 Uchwyt Ogi Drive** - opcja z dopłatą; mocowany do stelaża; metal malowany proszkowo, profil 60x60 mm

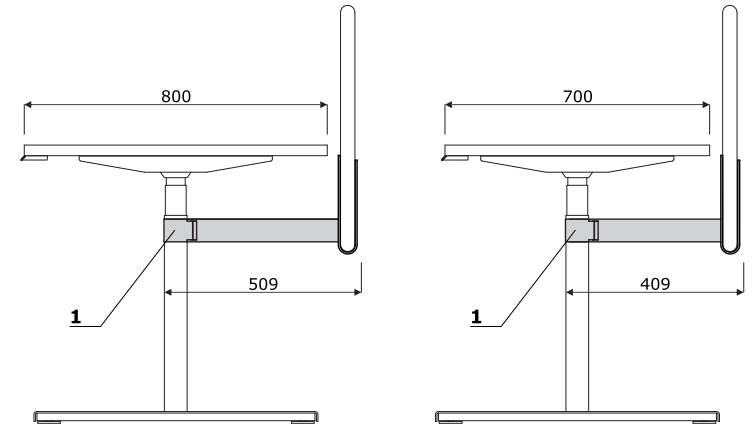

Uwaga - przy zakupie uchwyty Ogi Drive, mocowanego do stelaża - brak możliwości montażu listwy funkcjonalnej

## Uchwyty do paneli

- 1 Ogi, Ergonomic Master** - uchwyt do biurek pojedynczych (OPCJA Z DOPŁATĄ); przystosowany do montażu do blatów o grubości 16-30 mm
- 2 Ogi** - uchwyt do biurek typu bench w komplecie; metal malowany proszkowo; przystosowany do montażu do blatów o grubości 16-30 mm

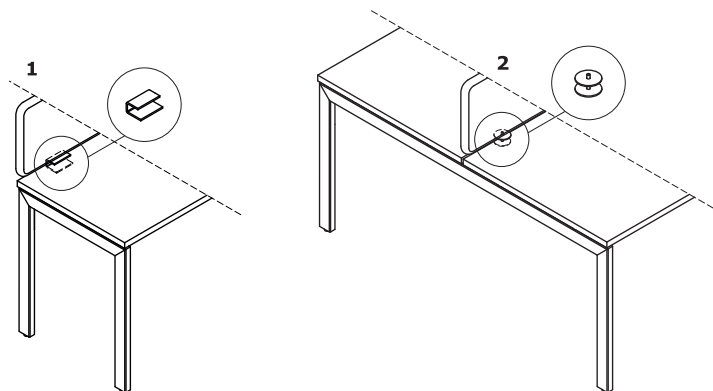

## Mocowanie paneli do biurek z blatem przesuwającym

- 1 Uchwyt do biurek pojedynczych** - mocowany do łącznicy metalowej
- 2 Uchwyt do biurek typu bench** - mocowany do łącznicy metalowej

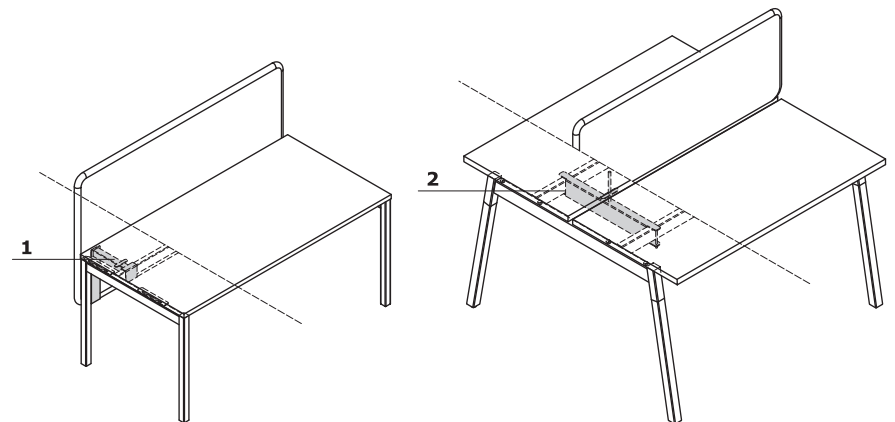

Uwaga - panel należy zamocować przed montażem blatu

**Przybiurkowe - do biurk pojedynczych**

- 1 Tkanina** - klasa akustyczności "A", możliwość wpinania szpilek
- 2 Mocowanie** - metal malowany proszkowo
- 3 Zamek błyskawiczny** - ozdobny, bez możliwości odpinania, kolor: grafit

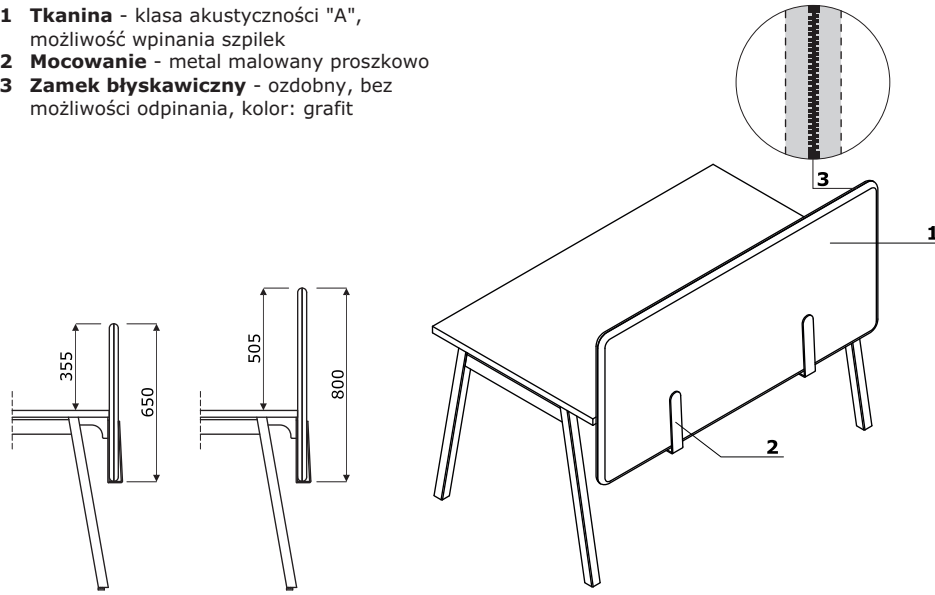
**Boczne - do biurk pojedynczych i biurk typu bench**

- 1 Panele Sonic** - klasa akustyczności "A", możliwość wpinania szpilek, zamek błyskawiczny, brak możliwości odpinania
- 2 Mocowanie paneli bocznych** - metal malowany proszkowo, kolor: M009 - aluminium półmat

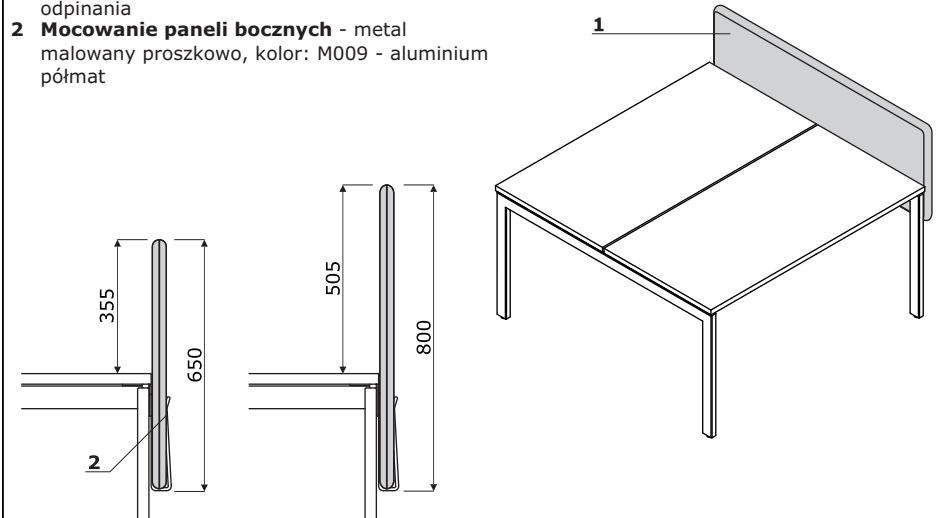
**Poprzeczne - do biurk typu bench**

- 1 Panel Sonic** - klasa akustyczności A, możliwość wpinania szpilek, zamek błyskawiczny ozdobny - kolor: grafit - brak możliwości odpinania
- 2 Mocowanie paneli poprzecznych do biurk Ogi** - stopa 2 szt.

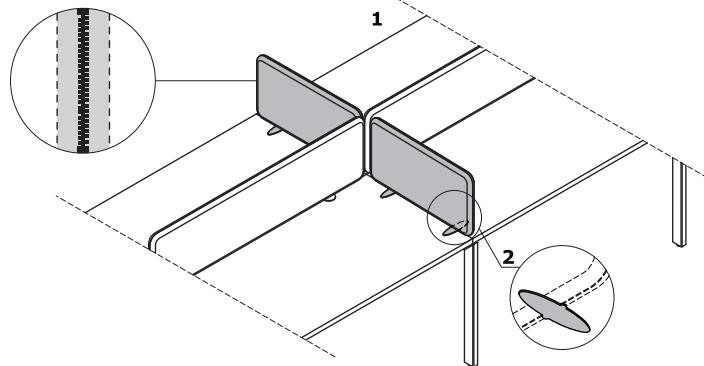
**Dodatki do listwy funkcyjnej**

- 1 Listwa funkcjna** - max obciążenie: 3,5 kg na punkt, 7 kg na stronę
- 2 Uchwyt na monitor** - metal malowany proszkowo, kolor: M009 - aluminium półmat
- 3 Piórnik** - metal malowany proszkowo
- 4 Półka** - format A4, metal malowany proszkowo
- 5 Organizer** - metal malowany proszkowo

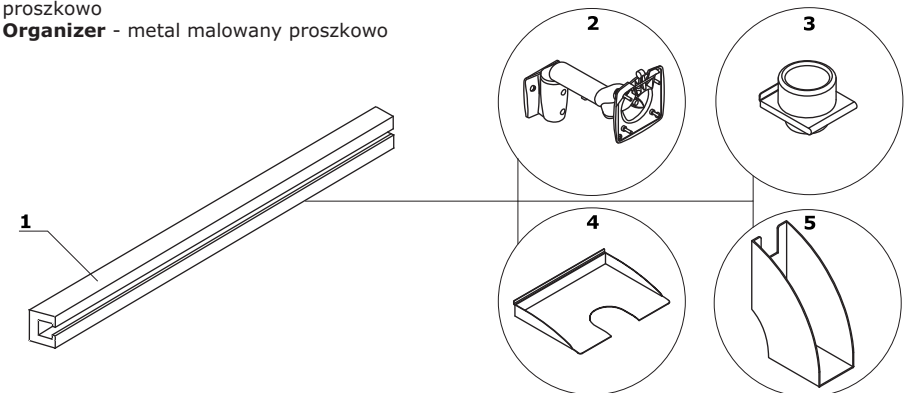

UWAGA: Możliwość mocowania akcesoriów wyłącznie z oferty .mdd

Nabiurkowe - do biurk pojedynczych i biurk typu bench							
Symbol	Cena netto PLN	Wymiary			Waga Obj. Opak.	Uwagi	
		Szer.	Gł.	Wys.			
<b>ZUS01</b>	<b>630,-</b>	990	40	350	4.4 kg 0.021 m3 2 szt.	do biurk o szer. 1000mm	
<b>ZUS12</b>	<b>675,-</b>	1190	40	350	5.4 kg 0.024 m3 2 szt.	do biurk o szer. 1200mm; Uwaga: możliwość mocowania do pojedynczego biurka, w opcji z dopłatą	
<b>ZUS14</b>	<b>710,-</b>	1390	40	350	6.1 kg 0.028 m3 2 szt.	do biurk o szer. 1400 mm; Uwaga: możliwość mocowania do pojedynczego biurka, w opcji z dopłatą	
<b>ZUS16</b>	<b>745,-</b>	1590	40	350	6.8 kg 0.032 m3 2 szt.	do biurk o szer. 1600mm; Uwaga: możliwość mocowania do pojedynczego biurka, w opcji z dopłatą	
<b>ZUS18</b>	<b>795,-</b>	1790	40	350	7.2 kg 0.035 m3 2 szt.	do biurk o szer. 1800mm; Uwaga: możliwość mocowania do pojedynczego biurka, w opcji z dopłatą	
<b>ZUS20</b>	<b>840,-</b>	1990	40	350	8.2 kg 0.039 m3 2 szt.	do biurk o szer. 2000mm; Uwaga: możliwość mocowania do pojedynczego biurka, w opcji z dopłatą	
<b>ZUS05</b>	<b>900,-</b>	990	40	500	4.9 kg 0.028 m3 2 szt.	do biurk o szer. 1000mm	
<b>ZUS52</b>	<b>950,-</b>	1190	40	500	6 kg 0.033 m3 2 szt.	do biurk o szer. 1200mm; Uwaga: możliwość mocowania do pojedynczego biurka, w opcji z dopłatą	
<b>ZUS54</b>	<b>1000,-</b>	1390	40	500	7.1 kg 0.039 m3 2 szt.	do biurk o szer. 1400mm; Uwaga: możliwość mocowania do pojedynczego biurka, w opcji z dopłatą	
<b>ZUS56</b>	<b>1050,-</b>	1590	40	500	7.8 kg 0.047 m3 2 szt.	do biurk o szer. 1600mm; Uwaga: możliwość mocowania do pojedynczego biurka, w opcji z dopłatą	
<b>ZUS58</b>	<b>1095,-</b>	1790	40	500	8.4 kg 0.049 m3 2 szt.	do biurk o szer. 1800mm; Uwaga: możliwość mocowania do pojedynczego biurka, w opcji z dopłatą	
<b>ZUS59</b>	<b>1155,-</b>	1990	40	500	8.3 kg 0.054 m3 2 szt.	do biurk o szer. 2000mm; Uwaga: możliwość mocowania do pojedynczego biurka, w opcji z dopłatą	

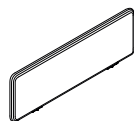

Dodatkowa dopłata							
II grupa cenowa	III grupa cenowa	Uchwyt do pojedynczego biurka	Listwa na akcesoria x1	Listwa na akcesoria x2	IV grupa cenowa		
124,-	274,-	78,-	206,-	346,-	384,-		
134,-	320,-	78,-	206,-	346,-	448,-		
154,-	362,-	78,-	206,-	346,-	510,-		
178,-	414,-	78,-	206,-	346,-	600,-		
198,-	468,-	78,-	206,-	346,-	675,-		
220,-	510,-	78,-	206,-	346,-	735,-		
124,-	274,-	78,-	206,-	346,-	384,-		
134,-	320,-	78,-	206,-	346,-	448,-		
154,-	362,-	78,-	206,-	346,-	510,-		
178,-	414,-	78,-	206,-	346,-	600,-		
198,-	468,-	78,-	206,-	346,-	675,-		
220,-	510,-	78,-	206,-	346,-	735,-		

Nabiurkowe - do biurkek typu bench z opcją blatu przesuwanego														
Symbol	Cena netto PLN	Wymiary			Waga Obj. Opak.	Uwagi	Dodatkowa dopłata							
		Szer.	Gł.	Wys.			II grupa cenowa	III grupa cenowa	Listwa na akcesoria x1	Listwa na akcesoria x2	IV grupa cenowa			
<b>ZUS01S</b>	<b>855,-</b>	990	40	350	6.4 kg 0.023 m3 2 szt.	do biurkek typu bench o szer. 1000mm	124,-	274,-	206,-	346,-	384,-			
<b>ZUS12S</b>	<b>895,-</b>	1190	40	350	7.4 kg 0.027 m3 2 szt.	do biurkek typu bench o szer. 1200mm	134,-	320,-	206,-	346,-	448,-			
<b>ZUS14S</b>	<b>935,-</b>	1390	40	350	8.1 kg 0.031 m3 2 szt.	do biurkek typu bench o szer. 1400mm	154,-	362,-	206,-	346,-	510,-			
<b>ZUS16S</b>	<b>970,-</b>	1590	40	350	8.8 kg 0.034 m3 2 szt.	do biurkek typu bench o szer. 1600mm	178,-	414,-	206,-	346,-	600,-			
<b>ZUS18S</b>	<b>1015,-</b>	1790	40	350	9.2 kg 0.038 m3 2 szt.	do biurkek typu bench o szer. 1000mm	198,-	468,-	206,-	346,-	675,-			
<b>ZUS20S</b>	<b>1065,-</b>	1990	40	350	10.2 kg 0.042 m3 2 szt.	do biurkek typu bench o szer. 2000mm	220,-	510,-	206,-	346,-	735,-			
<b>ZUS05S</b>	<b>1115,-</b>	990	40	500	6.9 kg 0.031 m3 2 szt.	do biurkek typu bench o szer. 1000mm	124,-	274,-	206,-	346,-	384,-			
<b>ZUS52S</b>	<b>1165,-</b>	1190	40	500	8 kg 0.036 m3 2 szt.	do biurkek typu bench o szer. 1200mm	134,-	320,-	206,-	346,-	448,-			
<b>ZUS54S</b>	<b>1220,-</b>	1390	40	500	9.1 kg 0.041 m3 2 szt.	do biurkek typu bench o szer. 1400mm	154,-	362,-	206,-	346,-	510,-			
<b>ZUS56S</b>	<b>1265,-</b>	1590	40	500	9.8 kg 0.05 m3 2 szt.	do biurkek typu bench o szer. 1600mm	178,-	414,-	206,-	346,-	600,-			
<b>ZUS58S</b>	<b>1315,-</b>	1790	40	500	10.4 kg 0.052 m3 2 szt.	do biurkek typu bench o szer. 1800mm	198,-	468,-	206,-	346,-	675,-			
<b>ZUS59S</b>	<b>1365,-</b>	1990	40	500	10.3 kg 0.057 m3 2 szt.	do biurkek typu bench o szer. 2000mm	220,-	510,-	206,-	346,-	735,-			

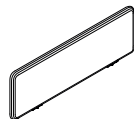

Przybiurkowe - do biurk pojedynczych							
Symbol	Cena netto PLN	Wymiary			Waga Obj. Opak.	Uwagi	
		Szer.	Gł.	Wys.			
<b>ZPS610</b>	<b>805,-</b>	990	40	650	8.1 kg 0.039 m3 2 szt.	do biurk o szer. 1000mm	
<b>ZPS612</b>	<b>900,-</b>	1190	40	650	6.3 kg 0.041 m3 1 szt.	do biurk o szer. 1200mm	
<b>ZPS614</b>	<b>1010,-</b>	1390	40	650	7.3 kg 0.048 m3 1 szt.	do biurk o szer. 1400mm	
<b>ZPS616</b>	<b>1120,-</b>	1590	40	650	8 kg 0.054 m3 1 szt.	do biurk o szer. 1600mm	
<b>ZPS618</b>	<b>1240,-</b>	1790	40	650	8.5 kg 0.061 m3 1 szt.	do biurk o szer. 1800mm	
<b>ZPS620</b>	<b>1375,-</b>	1990	40	650	8.5 kg 0.067 m3 1 szt.	do biurk o szer. 2000mm	
<b>ZPS810</b>	<b>875,-</b>	990	40	800	9.1 kg 0.047 m3 2 szt.	do biurk o szer. 1000mm	
<b>ZPS812</b>	<b>1025,-</b>	1190	40	800	7.6 kg 0.05 m3 1 szt.	do biurk o szer. 1200mm	
<b>ZPS814</b>	<b>1140,-</b>	1390	40	800	8.3 kg 0.058 m3 1 szt.	do biurk o szer. 1400mm	
<b>ZPS816</b>	<b>1265,-</b>	1590	40	800	9.1 kg 0.066 m3 1 szt.	do biurk o szer. 1600mm	
<b>ZPS818</b>	<b>1375,-</b>	1790	40	800	9.6 kg 0.075 m3 1 szt.	do biurk o szer. 1800mm	
<b>ZPS820</b>	<b>1515,-</b>	1990	40	800	10.5 kg 0.082 m3 1 szt.	do biurk o szer. 2000mm	

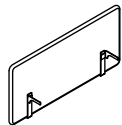

Dodatkowa dopłata							
II grupa cenowa	III grupa cenowa	Lista na akcesoria x1	IV grupa cenowa				
124,-	274,-	272,-	384,-				
134,-	320,-	272,-	448,-				
154,-	362,-	272,-	510,-				
178,-	414,-	272,-	600,-				
198,-	468,-	272,-	675,-				
220,-	510,-	272,-	735,-				
240,-	550,-	272,-	765,-				
260,-	630,-	272,-	885,-				
308,-	725,-	272,-	1020,-				
352,-	825,-	272,-	1170,-				
384,-	920,-	272,-	1330,-				
426,-	1020,-	272,-	1490,-				

Przybiurkowe - do biurk pojedynczych Ogi Drive z elektryczną regulacją wysokości, Ogi T						
Symbol	Cena netto PLN	Wymiary			Waga Obj. Opak.	Uwagi
		Szer.	Gł.	Wys.		
<b>ZPS632</b>	<b>1268,-</b>	1190	40	650	5 kg 0.041 m3 1 szt.	do biurk pojedynczych o szer. 1200mm
<b>ZPS634</b>	<b>1378,-</b>	1390	40	650	6.7 kg 0.048 m3 1 szt.	do biurk pojedynczych o szer. 1400mm
<b>ZPS636</b>	<b>1488,-</b>	1590	40	650	7.9 kg 0.054 m3 1 szt.	do biurk pojedynczych o szer. 1600mm
<b>ZPS638</b>	<b>1608,-</b>	1790	40	650	8.2 kg 0.061 m3 1 szt.	do biurk pojedynczych o szer. 1800mm
<b>ZPS640</b>	<b>1743,-</b>	1990	40	650	10 kg 0.067 m3 1 szt.	do biurk pojedynczych o szer. 2000mm
<b>ZPS832</b>	<b>1393,-</b>	1190	40	800	7.4 kg 0.05 m3 1 szt.	do biurk pojedynczych o szer. 1200mm
<b>ZPS834</b>	<b>1508,-</b>	1390	40	800	8.1 kg 0.058 m3 1 szt.	do biurk pojedynczych o szer. 1400mm
<b>ZPS836</b>	<b>1633,-</b>	1590	40	800	8.8 kg 0.066 m3 1 szt.	do biurk pojedynczych o szer. 1600mm
<b>ZPS838</b>	<b>1743,-</b>	1790	40	800	9.5 kg 0.075 m3 1 szt.	do biurk pojedynczych o szer. 1800mm
<b>ZPS840</b>	<b>1883,-</b>	1990	40	800	9.3 kg 0.082 m3 1 szt.	do biurk pojedynczych o szer. 2000mm

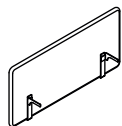

Dodatkowa dopłata						
II grupa cenowa	III grupa cenowa	Lista na akcesoria x1	IV grupa cenowa			
134,-	320,-	272,-	448,-			
154,-	362,-	272,-	510,-			
178,-	414,-	272,-	600,-			
198,-	468,-	272,-	675,-			
220,-	510,-	272,-	735,-			
260,-	630,-	272,-	885,-			
308,-	725,-	272,-	1020,-			
352,-	825,-	272,-	1170,-			
384,-	920,-	272,-	1330,-			
426,-	1020,-	272,-	1490,-			

Przybiurkowe - do biurk pojedynczych z opcją blatu przesuwnego							
Symbol	Cena netto PLN	Wymiary			Waga Obj. Opak.	Uwagi	
		Szer.	Gł.	Wys.			
<b>ZPS610S</b>	<b>790,-</b>	990	40	650	7 kg 0.039 m3 2 szt.	do biurk pojedynczych o szer. 1000mm	
<b>ZPS612S</b>	<b>875,-</b>	1190	40	650	7.1 kg 0.046 m3 2 szt.	do biurk pojedynczych o szer. 1200mm	
<b>ZPS614S</b>	<b>985,-</b>	1390	40	650	7.7 kg 0.053 m3 2 szt.	do biurk pojedynczych o szer. 1400mm	
<b>ZPS616S</b>	<b>1095,-</b>	1590	40	650	8.9 kg 0.059 m3 2 szt.	do biurk pojedynczych o szer. 1600mm	
<b>ZPS618S</b>	<b>1215,-</b>	1790	40	650	9.2 kg 0.066 m3 2 szt.	do biurk pojedynczych o szer. 1800mm	
<b>ZPS620S</b>	<b>1350,-</b>	1990	40	650	11 kg 0.072 m3 2 szt.	do biurk pojedynczych o szer. 2000mm	
<b>ZPS810S</b>	<b>855,-</b>	990	40	800	8 kg 0.047 m3 2 szt.	do biurk pojedynczych o szer. 1000mm	
<b>ZPS812S</b>	<b>1005,-</b>	1190	40	800	8.4 kg 0.055 m3 2 szt.	do biurk pojedynczych o szer. 1200mm	
<b>ZPS814S</b>	<b>1115,-</b>	1390	40	800	9.1 kg 0.063 m3 2 szt.	do biurk pojedynczych o szer. 1400mm	
<b>ZPS816S</b>	<b>1240,-</b>	1590	40	800	9.8 kg 0.072 m3 2 szt.	do biurk pojedynczych o szer. 1600mm	
<b>ZPS818S</b>	<b>1350,-</b>	1790	40	800	10.5 kg 0.08 m3 2 szt.	do biurk pojedynczych o szer. 1800mm	
<b>ZPS820S</b>	<b>1485,-</b>	1990	40	800	10.3 kg 0.088 m3 2 szt.	do biurk pojedynczych o szer. 2000mm	

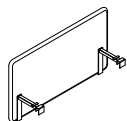

Dodatkowa dopłata							
II grupa cenowa	III grupa cenowa	Lista na akcesoria x1	IV grupa cenowa				
124,-	274,-	272,-	384,-				
134,-	320,-	272,-	448,-				
154,-	362,-	272,-	510,-				
178,-	414,-	272,-	600,-				
198,-	468,-	272,-	675,-				
220,-	510,-	272,-	735,-				
240,-	550,-	272,-	765,-				
260,-	630,-	272,-	885,-				
308,-	725,-	272,-	1020,-				
352,-	825,-	272,-	1170,-				
384,-	920,-	272,-	1330,-				
426,-	1020,-	272,-	1490,-				

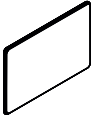
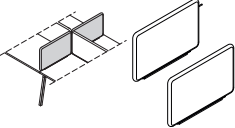
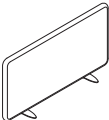

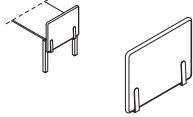
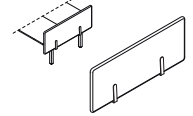
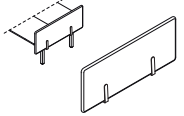

Przybiurkowe - do biurek typu bench Ogi Drive							
	Symbol	Cena netto PLN	Wymiary			Waga Obj. Opak.	Uwagi
			Szer.	Gł.	Wys.		
	<b>ZD812</b>	<b>970,-</b>	1190	40	800	6.6 kg 0.056 m3 2 szt.	do benchy o szer. 1200mm
	<b>ZD814</b>	<b>1055,-</b>	1390	40	800	8.6 kg 0.064 m3 2 szt.	do benchy o szer. 1400mm
	<b>ZD816</b>	<b>1130,-</b>	1590	40	800	8.2 kg 0.066 m3 1 szt.	do benchy o szer. 1600mm
	<b>ZD818</b>	<b>1215,-</b>	1790	40	800	8.9 kg 0.08 m3 2 szt.	do benchy o szer. 1800mm
	<b>ZD820</b>	<b>1285,-</b>	1990	40	800	9.7 kg 0.08 m3 2 szt.	do benchy o szer. 2000mm
	<b>Poprzeczne - do biurek typu bench Ogi</b>						
	<b>ZYS78</b>	<b>1285,-</b>	1600	40	350	5.4 kg 0.03 m3 2 szt.	do benchy (kpl. 2 szt.);
	<b>ZYS79</b>	<b>1800,-</b>	1600	40	500	6.6 kg 0.042 m3 2 szt.	
	<b>ZOS58</b>	<b>645,-</b>	577	40	350	2.3 kg 0.011 m3 1 szt.	do benchy Ogi (1 szt.);
	<b>ZOS68</b>	<b>670,-</b>	677	40	350	2.7 kg 0.013 m3 1 szt.	
	<b>ZOS78</b>	<b>690,-</b>	780	40	350	3.2 kg 0.015 m3 1 szt.	
	<b>ZOS10</b>	<b>935,-</b>	577	40	500	3.1 kg 0.015 m3 1 szt.	
	<b>ZOS40</b>	<b>955,-</b>	677	40	500	3.4 kg 0.018 m3 1 szt.	
	<b>ZOS79</b>	<b>970,-</b>	780	40	500	3.7 kg 0.021 m3 1 szt.	

Dodatkowa dopłata						
II grupa cenowa	III grupa cenowa	IV grupa cenowa				
260,-	630,-	885,-				
308,-	725,-	1020,-				
352,-	825,-	1170,-				
384,-	920,-	1330,-				
426,-	1020,-	1490,-				
178,-	426,-	620,-				
178,-	426,-	620,-				
68,-	168,-	230,-				
78,-	188,-	260,-				
88,-	208,-	308,-				
68,-	168,-	230,-				
78,-	188,-	260,-				
88,-	208,-	308,-				

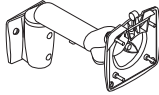

Boczne - do biurek pojedynczych							
Symbol	Cena netto PLN	Wymiary			Waga Obj. Opak.	Uwagi	
		Szer.	Gł.	Wys.			
 <b>ZUS80</b>	<b>805,-</b>	600	40	650	4.5 kg 0.021 m3 1 szt.	wysokość panela liczona od poziomu blatu wynosi 350 mm	
<b>ZUS90</b>	<b>820,-</b>	700	40	650	4.6 kg 0.024 m3 1 szt.		
<b>ZUS30</b>	<b>840,-</b>	800	40	650	5.2 kg 0.027 m3 1 szt.		
 <b>ZUS60</b>	<b>1140,-</b>	600	40	800	5.2 kg 0.025 m3 1 szt.	wysokość panela liczona od poziomu blatu wynosi 500 mm	
<b>ZUS70</b>	<b>1165,-</b>	700	40	800	5.5 kg 0.029 m3 1 szt.		
<b>ZUS50</b>	<b>1185,-</b>	800	40	800	6.1 kg 0.033 m3 1 szt.		
Boczne - do biurek typu bench							
 <b>ZUS11</b>	<b>950,-</b>	1200	40	650	5.4 kg 0.041 m3 1 szt.	wysokość panela liczona od poziomu blatu wynosi 350 mm	
<b>ZUS41</b>	<b>965,-</b>	1400	40	650	7.1 kg 0.047 m3 1 szt.		
<b>ZUS31</b>	<b>980,-</b>	1600	40	650	7.8 kg 0.053 m3 1 szt.		
<b>ZUS61</b>	<b>1285,-</b>	1200	40	800	7.5 kg 0.05 m3 1 szt.	wysokość panela liczona od poziomu blatu wynosi 500 mm	
<b>ZUS71</b>	<b>1310,-</b>	1400	40	800	7.3 kg 0.058 m3 1 szt.		
<b>ZUS51</b>	<b>1330,-</b>	1600	40	800	9.1 kg 0.065 m3 1 szt.		

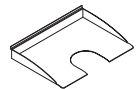
Dodatkowa dopłata							
II grupa cenowa	III grupa cenowa	IV grupa cenowa					
74,-	168,-	240,-					
84,-	188,-	274,-					
94,-	220,-	308,-					
134,-	332,-	458,-					
154,-	374,-	535,-					
178,-	426,-	610,-					
134,-	320,-	448,-					
154,-	374,-	520,-					
178,-	414,-	600,-					
260,-	630,-	885,-					
308,-	735,-	1030,-					
352,-	835,-	1225,-					

Akcesoria do listwy funkcyjnej							
	Symbol	Cena netto PLN	Wymiary			Waga Obj. Opak.	Uwagi
			Szer.	Gł.	Wys.		
	<b>D1</b>	<b>1105,-</b>	300	130	130	1.9 kg 0.012 m3 1 szt.	uchwyt na monitor, max wielkość 22"
	<b>D5</b>	<b>110,-</b>	164	83	146	0.2 kg 0.002 m3 1 szt.	Piórnik - tworzywo czarne, uchwyt - metal szary
	<b>D6</b>	<b>202,-</b>	327	35	210	0.95 kg 0.002 m3 1 szt.	półka format A4
	<b>D7</b>	<b>264,-</b>	93	250	180	0.6 kg 0.004 m3 1 szt.	organizer

Dodatkowa dopłata							

## Zestawienie kolorystyczne - Twin - panele biurkowe

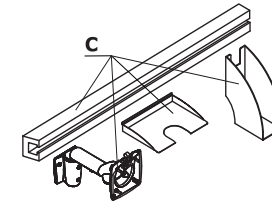
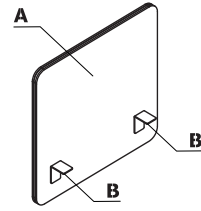
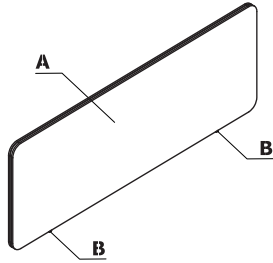

Materiał	Kolor	Panele														
		A - Panel	B - Uchwyt	C - Akcesoria												
Tkanina	Nemo	✓														
	Runner	II grupa														
	Medley	II grupa														
	**Atlantic	II grupa														
	Vita	II grupa														
	Mica	II grupa														
	Go Check	II grupa														
	****Charles	II grupa														
	*Tkanina powierzona	II grupa														
	Synergy	III grupa														
	***Silvertex	III grupa														
	Tessa	III grupa														
	Oceanic	III grupa														
	Quest	III grupa														
	Grain	III grupa														
	Atlas	IV grupa														

\* Zastosowanie tkaniny powierzonej wymaga przeprowadzenia prób tapicerskich, w celu sprawdzenia możliwości wykonawczych

\*\* Istnieje możliwość zamówienia produktu w pełnej kolorystyce Atlantic wg wzornika Gabriel w terminie nie krótszym niż 7 tygodni

\*\*\* Istnieje możliwość zamówienia produktu w pełnej kolorystyce Silvertex wg wzornika Spradling w terminie nie krótszym niż 15 dni roboczych

\*\*\*\* Istnieje możliwość zamówienia produktu w pełnej kolorystyce Charles wg wzornika Dekoma w standardowym terminie realizacji.

Materiał	Kolor	Panele													
		A - Panel	B - Uchwyt	C - Akcesoria											
Metal	M009 - aluminium półmat RAL 9006		✓	✓											
	M015 - biały półmat RAL 9010		✓												
	M115 - czarny półmat RAL 9005		✓												
	M154 - antracyt półmat RAL 7043		✓												

### Nabiurkowe - do biurek pojedynczych i biurek typu bench

- 1 Panel Twin** - tapicerowany, możliwość wpinania pinezek, pasek tworzywowy
- 2 Element dekoracyjny** - pasek tworzywowy, kolor: szary
- 3 Konstrukcja** - płyta wiórowa pokryta obustronnie pianką poliuretanową

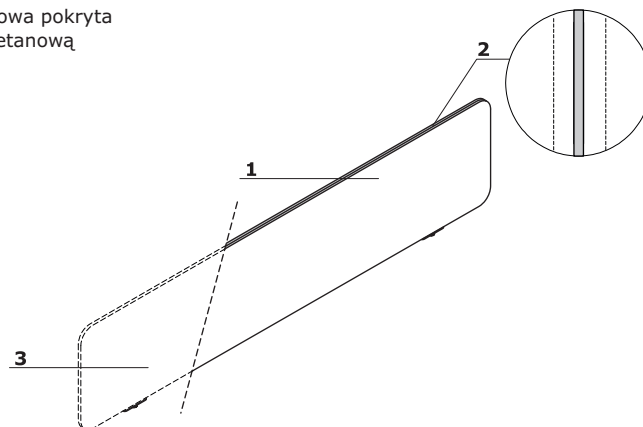

### Mocowanie paneli do biurek z blatem przesuwnym

- 1 Uchwyt do biurek pojedynczych** - mocowany do łączyny metalowej
- 2 Uchwyt do biurek typu bench** - mocowany do łączyny metalowej

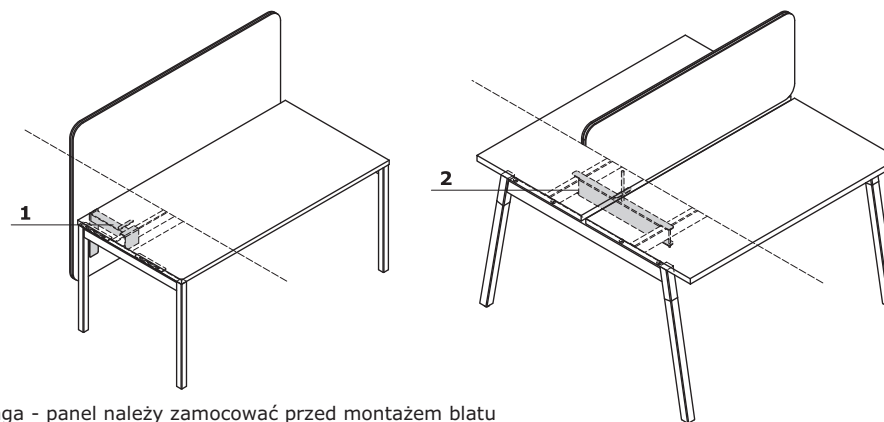

### Uchwyty do paneli

- 1 Ogi, Ergonomic Master** - uchwyt do biurek pojedynczych (OPCJA Z DOPŁATĄ); przystosowany do montażu do blatów o grubości 16-30 mm
- 2 Ogi** - uchwyt do biurek typu bench w komplecie; metal malowany proszkowo; przystosowany do montażu do blatów o grubości 16-30 mm

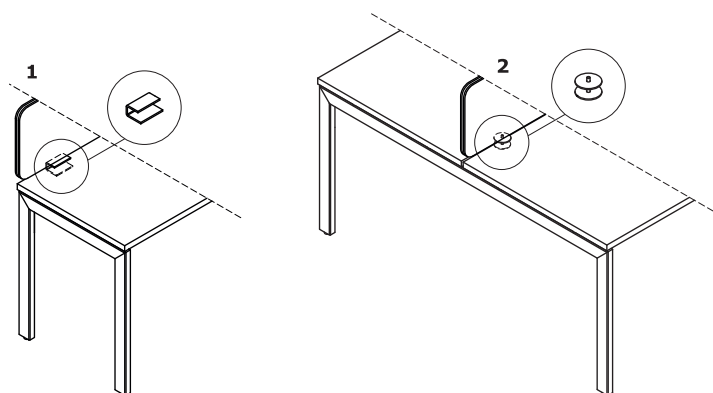

### Poprzeczne - do biurek typu bench

- 1 Panel Twin** - tapicerowany, możliwość wpinania pinezek, pasek tworzywowy
- 2 Mocowanie paneli poprzecznych do biurek Ogi** - stopa 2 szt.

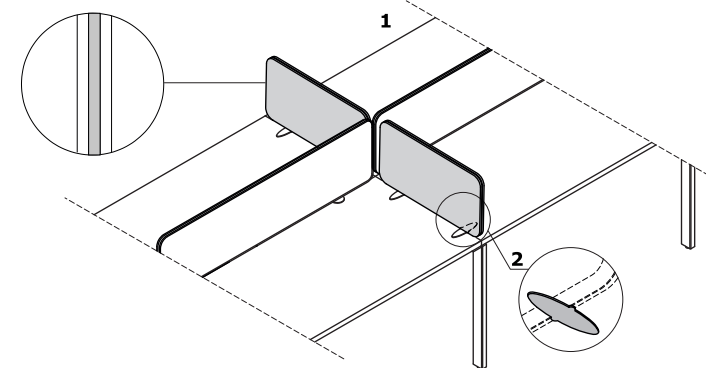

**Boczne - do biurk pojedynczych i biurk typu bench**

- 1 **Tkanina** - możliwość przypinania pinezek
- 2 **Mocowanie paneli bocznych** - metal malowany proszkowo, kolor: M009 - aluminium półmat

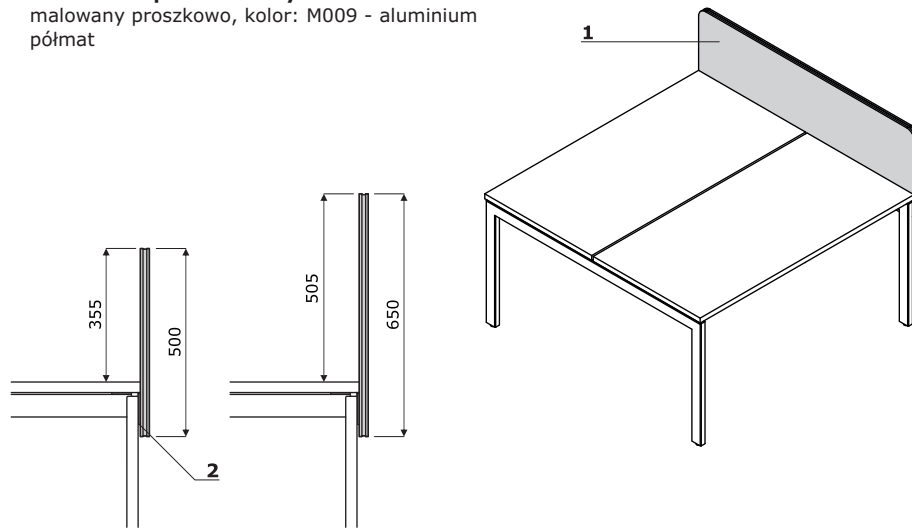
**Dodatki do listwy funkcyjnej**

- 1 **Listwa funkcyjna** - max obciążenie: 3,5 kg na punkt, 7 kg na stronę
- 2 **Uchwyt na monitor** - metal malowany proszkowo, kolor: M009 - aluminium półmat
- 3 **Piórnik** - metal malowany proszkowo
- 4 **Półka** - format A4, metal malowany proszkowo
- 5 **Organizer** - metal malowany proszkowo

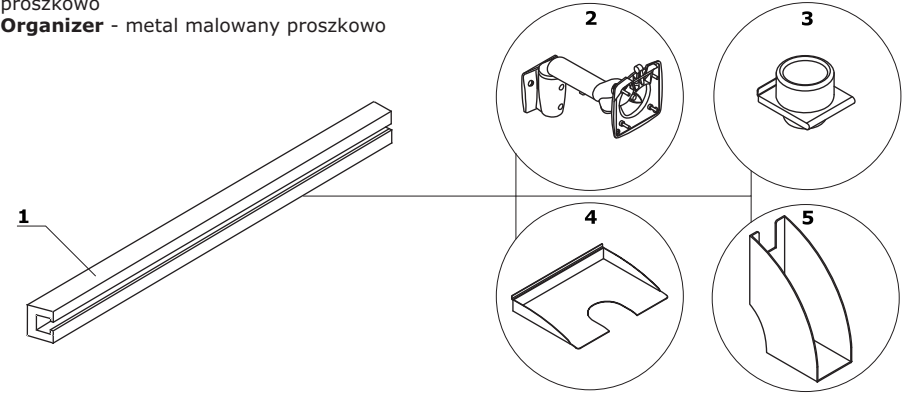

UWAGA: Możliwość mocowania akcesoriów wyłącznie z oferty .mdd

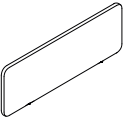
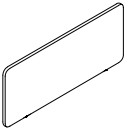
Nabiurkowe - do biurek pojedynczych i biurek typu bench							
	Symbol	Cena netto PLN	Wymiary			Waga Obj. Opak.	Uwagi
			Szer.	Gł.	Wys.		
	ZUT01	348,-	990	30	350	6.5 kg 0.016 m3 2 szt.	do biurek o szer. 1000 mm
	ZUT12	364,-	1190	30	350	8.1 kg 0.019 m3 2 szt.	do biurek o szer. 1200 mm;
	ZUT14	386,-	1390	30	350	9.6 kg 0.021 m3 2 szt.	do biurek o szer. 1400 mm;
	ZUT16	404,-	1590	30	350	10.7 kg 0.024 m3 2 szt.	do biurek o szer. 1600 mm;
	ZUT18	426,-	1790	30	350	10.9 kg 0.027 m3 2 szt.	do biurek o szer. 1800 mm;
	ZUT20	454,-	1990	30	350	11.9 kg 0.029 m3 2 szt.	do biurek o szer. 2000 mm;
	ZUT05	426,-	990	30	500	8.7 kg 0.02 m3 2 szt.	do biurek o szer. 1000 mm
	ZUT52	464,-	1190	30	500	10.6 kg 0.024 m3 2 szt.	do biurek o szer. 1200 mm;
	ZUT54	505,-	1390	30	500	13.3 kg 0.028 m3 2 szt.	do biurek o szer. 1400mm;
	ZUT56	550,-	1590	30	500	14 kg 0.031 m3 2 szt.	do biurek o szer. 1600mm;
	ZUT58	595,-	1790	30	500	15.4 kg 0.035 m3 2 szt.	do biurek o szer. 1800mm;
	ZUT59	625,-	1990	30	500	16.4 kg 0.039 m3 2 szt.	do biurek o szer. 2000mm;

Dodatkowa dopłata						
II grupa cenowa	III grupa cenowa	Uchwyt do pojedynczego biurka	Listwa na akcesoria x1	Listwa na akcesoria x2	IV grupa cenowa	
114,-	250,-	78,-	156,-	286,-	362,-	
134,-	308,-	78,-	156,-	286,-	438,-	
154,-	362,-	78,-	156,-	286,-	510,-	
178,-	414,-	78,-	156,-	286,-	600,-	
198,-	458,-	78,-	156,-	286,-	665,-	
220,-	510,-	78,-	156,-	286,-	735,-	
114,-	250,-	78,-	156,-	286,-	362,-	
134,-	308,-	78,-	156,-	286,-	438,-	
154,-	362,-	78,-	156,-	286,-	510,-	
178,-	414,-	78,-	156,-	286,-	600,-	
198,-	458,-	78,-	156,-	286,-	665,-	
220,-	510,-	78,-	156,-	286,-	735,-	

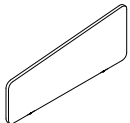
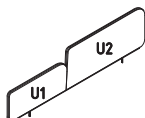
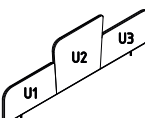
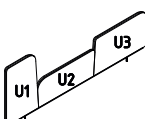
<b>Nabiurkowe - do biurek pojedynczych i biurek typu bench - panel asymetryczny</b>							
	Symbol	Cena netto PLN	Wymiary			Waga Obj. Opak.	Uwagi
			Szer.	Gł.	Wys.		
	<b>ZUT02</b>	<b>436,-</b>	990	30	350 450	8 kg 0.018 m3 2 szt.	do biurek o szer. 1000 mm; panel asymetryczny
	<b>ZUT22</b>	<b>464,-</b>	1190	30	350 450	8.6 kg 0.021 m3 2 szt.	do biurek o szer. 1200 mm; panel asymetryczny
	<b>ZUT24</b>	<b>494,-</b>	1390	30	350 450	9.7 kg 0.025 m3 2 szt.	do biurek o szer. 1400 mm; panel asymetryczny
	<b>ZUT26</b>	<b>515,-</b>	1590	30	350 450	11 kg 0.028 m3 2 szt.	do biurek o szer. 1600 mm; panel asymetryczny
	<b>ZUT28</b>	<b>550,-</b>	1790	30	350 450	12.1 kg 0.035 m3 2 szt.	do biurek o szer. 1800 mm; panel asymetryczny
	<b>ZUT29</b>	<b>580,-</b>	1990	30	350 450	14 kg 0.039 m3 2 szt.	do biurek o szer. 2000 mm; panel asymetryczny
	<b>Nabiurkowe - do biurek typu bench</b>						
	<b>ZUT32</b>	<b>610,-</b>	1190	30	360	6.5 kg 0.024 m3 1 szt.	do benchy o szer. 1200 mm;
	<b>ZUT34</b>	<b>660,-</b>	1390	30	360	8.8 kg 0.018 m3 1 szt.	do benchy o szer. 1400 mm;
	<b>ZUT36</b>	<b>805,-</b>	1590	30	560	11.9 kg 0.033 m3 1 szt.	do benchy o szer. 1600 mm;
	<b>ZUT38</b>	<b>925,-</b>	1790	30	560	13 kg 0.037 m3 1 szt.	do benchy o szer. 1800 mm;
	<b>ZUT46</b>	<b>805,-</b>	1590	30	560	10 kg 0.033 m3 1 szt.	do benchy o szer. 1600 mm;
	<b>ZUT48</b>	<b>925,-</b>	1790	30	560	11.1 kg 0.037 m3 1 szt.	do benchy o szer. 1800 mm;

Dodatkowa dopłata						
II grupa cenowa	III grupa cenowa	Uchwyt do pojedynczego biurka	Listwa na akcesoria x1	Listwa na akcesoria x2	IV grupa cenowa	
114,-	250,-	78,-	156,-	286,-	362,-	
134,-	308,-	78,-	156,-	286,-	438,-	
154,-	362,-	78,-	156,-	286,-	510,-	
178,-	414,-	78,-	156,-	286,-	600,-	
198,-	458,-	78,-	156,-	286,-	665,-	
220,-	510,-	78,-	156,-	286,-	735,-	
134,-	320,-				458,-	
154,-	374,-				520,-	
188,-	448,-				650,-	
208,-	500,-				715,-	
188,-	448,-				650,-	
208,-	500,-				715,-	

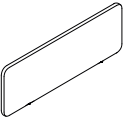
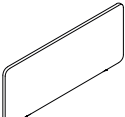

Nabiurkowe - do biurka typu bench z opcją blatu przesuwanego							
	Symbol	Cena netto PLN	Wymiary			Waga Obj. Opak.	Uwagi
			Szer.	Gł.	Wys.		
	<b>ZUT01S</b>	<b>585,-</b>	990	30	350	8.5 kg 0.018 m3 2 szt.	do biurka typu bench o szer. 1000 mm
	<b>ZUT12S</b>	<b>600,-</b>	1190	30	350	10.1 kg 0.021 m3 2 szt.	do biurka typu bench o szer. 1200 mm
	<b>ZUT14S</b>	<b>620,-</b>	1390	30	350	11.6 kg 0.024 m3 2 szt.	do biurka typu bench o szer. 1400 mm
	<b>ZUT16S</b>	<b>635,-</b>	1590	30	350	12.7 kg 0.027 m3 2 szt.	do biurka typu bench o szer. 1600 mm
	<b>ZUT18S</b>	<b>660,-</b>	1790	30	350	12.9 kg 0.029 m3 2 szt.	do biurka typu bench o szer. 1800 mm
	<b>ZUT20S</b>	<b>690,-</b>	1990	30	350	13.9 kg 0.032 m3 2 szt.	do biurka typu bench o szer. 2000 mm
	<b>ZUT05S</b>	<b>660,-</b>	990	30	500	10.7 kg 0.023 m3 2 szt.	do biurka typu bench o szer. 1000 mm
	<b>ZUT52S</b>	<b>700,-</b>	1190	30	500	12.6 kg 0.027 m3 2 szt.	do biurka typu bench o szer. 1200 mm
	<b>ZUT54S</b>	<b>735,-</b>	1390	30	500	15.3 kg 0.03 m3 2 szt.	do biurka typu bench o szer. 1400 mm
	<b>ZUT56S</b>	<b>775,-</b>	1590	30	500	16 kg 0.034 m3 2 szt.	do biurka typu bench o szer. 1600 mm
	<b>ZUT58S</b>	<b>815,-</b>	1790	30	500	17.4 kg 0.038 m3 2 szt.	do biurka typu bench o szer. 1800 mm
	<b>ZUT59S</b>	<b>850,-</b>	1990	30	500	18.4 kg 0.041 m3 2 szt.	do biurka typu bench o szer. 2000 mm

Dodatkowa dopłata						
II grupa cenowa	III grupa cenowa	Listwa na akcesoria x1	Listwa na akcesoria x2	IV grupa cenowa		
114,-	250,-	156,-	286,-	362,-		
134,-	308,-	156,-	286,-	438,-		
154,-	362,-	156,-	286,-	510,-		
178,-	414,-	156,-	286,-	600,-		
198,-	458,-	156,-	286,-	665,-		
220,-	510,-	156,-	286,-	735,-		
114,-	250,-	156,-	286,-	362,-		
134,-	308,-	156,-	286,-	438,-		
154,-	362,-	156,-	286,-	510,-		
178,-	414,-	156,-	286,-	600,-		
198,-	458,-	156,-	286,-	665,-		
220,-	510,-	156,-	286,-	735,-		

Nabiurkowe - do biurek typu bench z opcją blatu przesuwnego - panel asymetryczny						
Symbol	Cena netto PLN	Wymiary			Waga Obj. Opak.	Uwagi
		Szer.	Gł.	Wys.		
<b>ZUT02S</b>	<b>675,-</b>	990	30	350 450	10 kg 0.021 m3 2 szt.	do biurek typu bench o szer. 1000 mm; panel asymetryczny
<b>ZUT22S</b>	<b>700,-</b>	1190	30	350 450	10.6 kg 0.024 m3 2 szt.	do biurek typu bench o szer. 1200 mm; panel asymetryczny
<b>ZUT24S</b>	<b>725,-</b>	1390	30	350 450	11.7 kg 0.027 m3 2 szt.	do biurek typu bench o szer. 1400 mm; panel asymetryczny
<b>ZUT26S</b>	<b>745,-</b>	1590	30	350 450	13 kg 0.03 m3 2 szt.	do biurek typu bench o szer. 1600 mm; panel asymetryczny
<b>ZUT28S</b>	<b>775,-</b>	1790	30	350 450	14.1 kg 0.038 m3 2 szt.	do biurek typu bench o szer. 1800 mm; panel asymetryczny
<b>ZUT29S</b>	<b>805,-</b>	1990	30	350 450	16 kg 0.041 m3 2 szt.	do biurek typu bench o szer. 2000 mm; panel asymetryczny

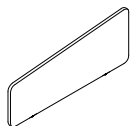

Dodatkowa dopłata						
II grupa cenowa	III grupa cenowa	Listwa na akcesoria x1	Listwa na akcesoria x2	IV grupa cenowa		
114,-	250,-	156,-	286,-	362,-		
134,-	308,-	156,-	286,-	438,-		
154,-	362,-	156,-	286,-	510,-		
178,-	414,-	156,-	286,-	600,-		
198,-	458,-	156,-	286,-	665,-		
220,-	510,-	156,-	286,-	735,-		



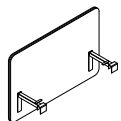

Przybiurkowe - do biurek pojedynczych z opcją blatu przesuwnego						
Symbol	Cena netto PLN	Wymiary			Waga Obj. Opak.	Uwagi
		Szer.	Gł.	Wys.		
<b>ZPT610S</b>	<b>710,-</b>	990	30	650	11.5 kg 0.031 m3 2 szt.	do biurek pojedynczych o szer. 1000mm
<b>ZPT612S</b>	<b>730,-</b>	1190	30	650	13.5 kg 0.035 m3 2 szt.	do biurek pojedynczych o szer. 1200mm
<b>ZPT614S</b>	<b>750,-</b>	1390	30	650	15.2 kg 0.04 m3 2 szt.	do biurek pojedynczych o szer. 1400mm
<b>ZPT616S</b>	<b>775,-</b>	1590	30	650	17.2 kg 0.045 m3 2 szt.	do biurek pojedynczych o szer. 1600mm
<b>ZPT618S</b>	<b>800,-</b>	1790	30	650	19.1 kg 0.049 m3 2 szt.	do biurek pojedynczych o szer. 1800mm
<b>ZPT620S</b>	<b>820,-</b>	1990	30	650	20.5 kg 0.054 m3 2 szt.	do biurek pojedynczych o szer. 2000mm
<b>ZPT810S</b>	<b>875,-</b>	990	30	800	13.5 kg 0.036 m3 2 szt.	do biurek pojedynczych o szer. 1000mm
<b>ZPT812S</b>	<b>900,-</b>	1190	30	800	16 kg 0.042 m3 2 szt.	do biurek pojedynczych o szer. 1200mm
<b>ZPT814S</b>	<b>925,-</b>	1390	30	800	18 kg 0.047 m3 2 szt.	do biurek pojedynczych o szer. 1400mm
<b>ZPT816S</b>	<b>945,-</b>	1590	30	800	20.5 kg 0.053 m3 2 szt.	do biurek pojedynczych o szer. 1600mm
<b>ZPT818S</b>	<b>965,-</b>	1790	30	800	22.5 kg 0.059 m3 2 szt.	do biurek pojedynczych o szer. 1800mm
<b>ZPT820S</b>	<b>985,-</b>	1990	30	800	25 kg 0.064 m3 2 szt.	do biurek pojedynczych o szer. 2000mm

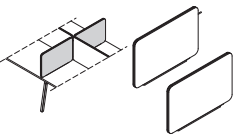
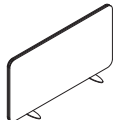
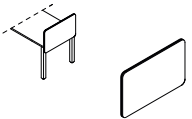

Dodatkowa dopłata							
II grupa cenowa	III grupa cenowa	Lista na akcesoria x1	IV grupa cenowa				
124,-	274,-	272,-	384,-				
134,-	320,-	272,-	448,-				
154,-	362,-	272,-	510,-				
178,-	414,-	272,-	600,-				
198,-	468,-	272,-	675,-				
220,-	510,-	272,-	735,-				
240,-	550,-	272,-	765,-				
260,-	630,-	272,-	885,-				
308,-	725,-	272,-	1020,-				
352,-	825,-	272,-	1170,-				
384,-	920,-	272,-	1330,-				
426,-	1020,-	272,-	1490,-				

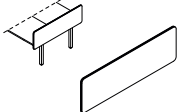
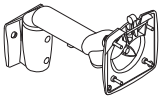
Poprzeczne - do biurek typu bench							
	Symbol	Cena netto PLN	Wymiary			Waga Obj. Opak.	Uwagi
			Szer.	Gł.	Wys.		
	<b>ZYT78</b>	<b>605,-</b>	1600	30	350	12 kg 0.014 m3 2 szt.	do benchy (kpl. 2 szt.);
	<b>ZYT79</b>	<b>900,-</b>	1600	30	500	12 kg 0.021 m3 2 szt.	
	<b>ZOT58</b>	<b>332,-</b>	577	30	350	3.4 kg 0.005 m3 1 szt.	do benchy Ogi (1 szt.);
	<b>ZOT68</b>	<b>342,-</b>	677	30	350	3.9 kg 0.006 m3 1 szt.	
	<b>ZOT78</b>	<b>348,-</b>	777	30	350	4.5 kg 0.007 m3 1 szt.	
	<b>ZOT10</b>	<b>476,-</b>	577	30	500	5.3 kg 0.008 m3 1 szt.	
	<b>ZOT40</b>	<b>488,-</b>	677	30	500	5.6 kg 0.009 m3 1 szt.	
	<b>ZOT79</b>	<b>494,-</b>	777	30	500	6.3 kg 0.01 m3 1 szt.	
Boczne - do biurek pojedynczych							
	<b>ZUT80</b>	<b>510,-</b>	600	30	500	5.7 kg 0.011 m3 2 szt.	wysokość panela liczona od poziomu blatu wynosi 350 mm
	<b>ZUT90</b>	<b>520,-</b>	700	30	500	6.4 kg 0.013 m3 2 szt.	
	<b>ZUT30</b>	<b>540,-</b>	800	30	500	7.3 kg 0.014 m3 2 szt.	
	<b>ZUT60</b>	<b>550,-</b>	600	30	650	7 kg 0.014 m3 2 szt.	wysokość panela liczona od poziomu blatu wynosi 500 mm
	<b>ZUT70</b>	<b>565,-</b>	700	30	650	8.1 kg 0.016 m3 2 szt.	
	<b>ZUT50</b>	<b>580,-</b>	800	30	650	9.1 kg 0.018 m3 2 szt.	

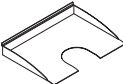
Dodatkowa dopłata						
II grupa cenowa	III grupa cenowa	IV grupa cenowa				
178,-	426,-	620,-				
178,-	426,-	620,-				
68,-	154,-	220,-				
78,-	188,-	260,-				
88,-	208,-	298,-				
68,-	154,-	220,-				
78,-	188,-	260,-				
88,-	208,-	298,-				
74,-	168,-	230,-				
78,-	188,-	260,-				
88,-	208,-	308,-				
74,-	168,-	230,-				
78,-	188,-	260,-				
88,-	208,-	308,-				

Boczne - do biurk typu bench							
	Symbol	Cena netto PLN	Wymiary			Waga Obj. Opak.	Uwagi
			Szer.	Gł.	Wys.		
	ZUT11	700,-	1200	30	500	10.2 kg 0.02 m3 2 szt.	wysokość panela liczona od poziomu blatu wynosi 350 mm
	ZUT41	710,-	1400	30	500	11.8 kg 0.023 m3 2 szt.	
	ZUT31	715,-	1600	30	500	13.3 kg 0.026 m3 2 szt.	
	ZUT61	775,-	1200	30	650	12.7 kg 0.025 m3 2 szt.	wysokość panela liczona od poziomu blatu wynosi 500 mm
	ZUT71	795,-	1400	30	650	14.5 kg 0.029 m3 2 szt.	
	ZUT51	800,-	1600	30	650	17.2 kg 0.033 m3 2 szt.	
Akcesoria do listwy funkcyjnej							
	D1	1105,-	300	130	130	1.9 kg 0.012 m3 1 szt.	uchwyt na monitor, max wielkość 22"
	D5	110,-	164	83	146	0.2 kg 0.002 m3 1 szt.	Piórnik - tworzywo czarne, uchwyt - metal szary
	D6	202,-	327	35	210	0.95 kg 0.002 m3 1 szt.	półka format A4
	D7	264,-	93	250	180	0.6 kg 0.004 m3 1 szt.	organizer

Dodatkowa dopłata									
II grupa cenowa	III grupa cenowa	IV grupa cenowa							
134,-	320,-	448,-							
154,-	362,-	510,-							
178,-	414,-	600,-							
134,-	320,-	448,-							
154,-	362,-	510,-							
178,-	414,-	600,-							

Zestawienie kolorystyczne - Sonic - panele wolnostojące

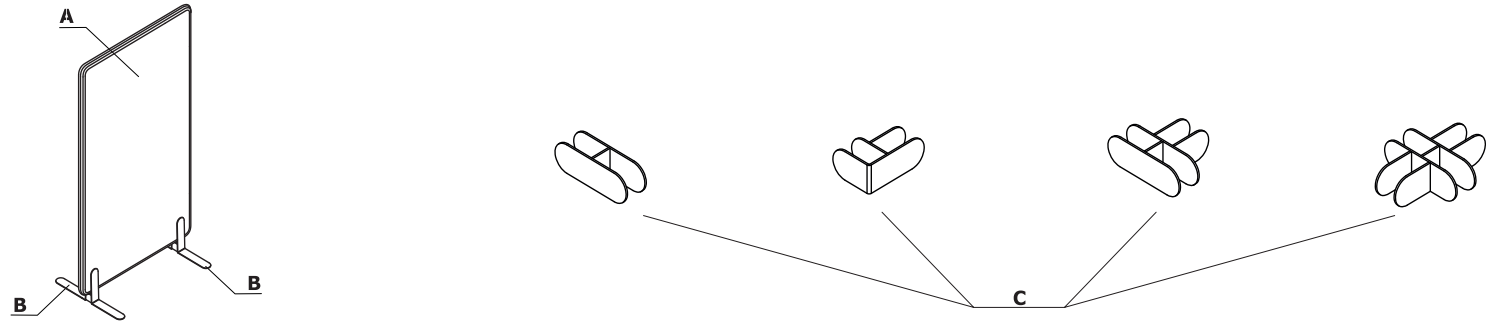

Materiał	Kolor	Panele wolnostojące																
		A - Panel	B - Stopa	C - Łączniki														
Tkanina	Nemo	✓																
	Runner	II grupa ✓																
	Medley	II grupa ✓																
	**Atlantic	II grupa ✓																
	Vita	II grupa ✓																
	Mica	II grupa ✓																
	Go Check	II grupa ✓																
	****Charles	II grupa ✓																
	*Tkanina powierzona	II grupa ✓																
	Synergy	III grupa ✓																
	***Silvertex	III grupa ✓																
	Tessa	III grupa ✓																
	Oceanic	III grupa ✓																
	Quest	III grupa ✓																
	Grain	III grupa ✓																
	Atlas	IV grupa ✓																

\* Zastosowanie tkaniny powierzonej wymaga przeprowadzenia prób tapicerskich, w celu sprawdzenia możliwości wykonawczych  
 \*\* Istnieje możliwość zamówienia produktu w pełnej kolorystyce Atlantic wg wzornika Gabriel w terminie nie krótszym niż 7 tygodni

\*\*\* Istnieje możliwość zamówienia produktu w pełnej kolorystyce Silvertex wg wzornika Spradling w terminie nie krótszym niż 15 dni roboczych  
 \*\*\*\* Istnieje możliwość zamówienia produktu w pełnej kolorystyce Charles wg wzornika Dekoma w standardowym terminie realizacji.

Materiał	Kolor	Panele wolnostojące													
		A - Panel	B - Stopa	C - Łączniki											
Metal	M009 - aluminium półmat RAL 9006		✓	✓											
	M015 - biały półmat RAL 9010		✓												
	M115 - czarny półmat RAL 9005		✓												
	M154 - antracyt półmat RAL 7043		✓												

## Panele wolnostojące

- 1 **Panel** - klasa akustyczności "A", tapicerowany; możliwość wpinania szpilek
- 2 **Zamek błyskawiczny** - ozdobny, bez możliwości odpinania, kolor: grafit
- 3 **Rama** - konstrukcja z litego drewna klejonego
- 4 **Wypełnienie** - włóknina akustyczna o wysokim stopniu pochłaniania i rozpraszania dźwięków
- 5 **Stopa wolnostojąca** - metal malowany proszkowo
- 6 **Stopka dystansowa** - metal malowany proszkowo; do zastosowania wyłącznie w panelach ustawianych pomiędzy biurkami, lub z innym stabilnym podparciem z obu stron
- 7 **Kółka z hamulcem** - Ø65 mm
- 8 **Tablica magnetyczna** - suchościernalna

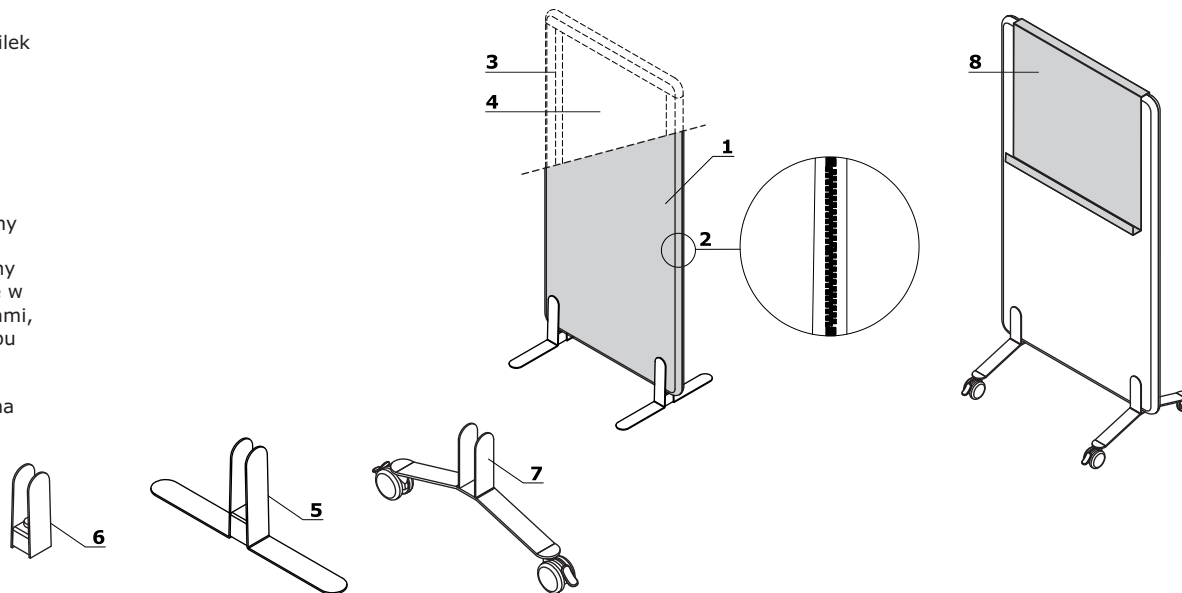

## Łączniki do paneli wolnostojących Sonic

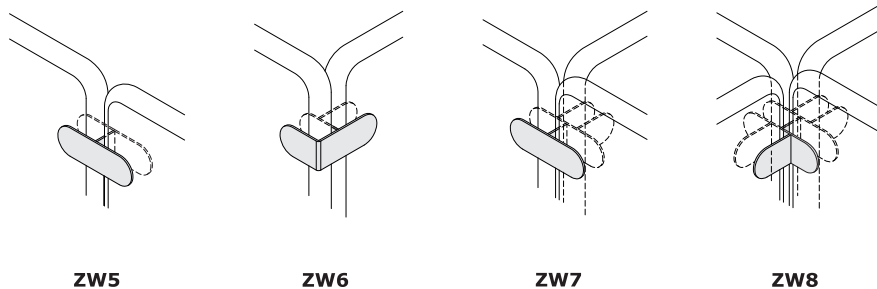

- 1 **Łącznik** - metal malowany proszkowo



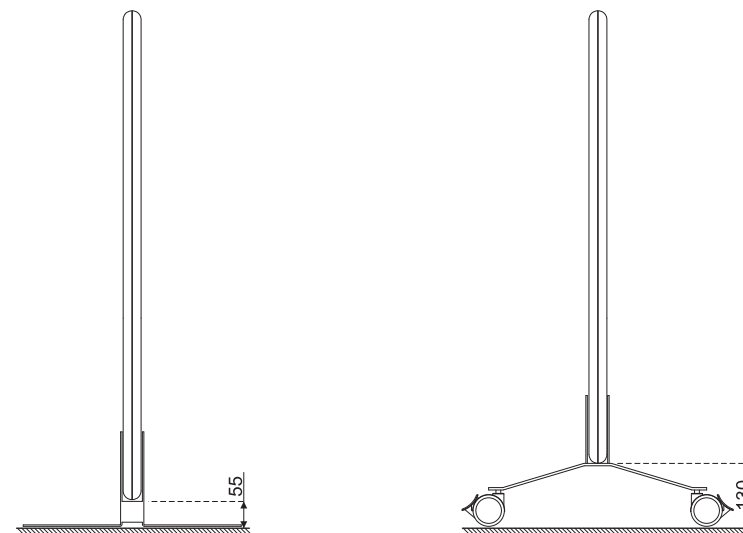

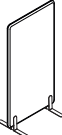
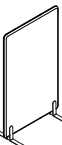

## Wymiary (mm)



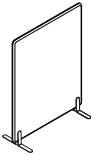

Panele wolnostojące							
	Symbol	Cena netto PLN	Wymiary			Waga Obj. Opak.	Uwagi
			Szer.	Gł.	Wys.		
	<b>ZW592</b>	<b>935,-</b>	590	40	1250	8.3 kg 0.046 m3 2 szt.	
	<b>ZW594</b>	<b>1035,-</b>	590	40	1450	8.1 kg 0.052 m3 2 szt.	
	<b>ZW596</b>	<b>1140,-</b>	590	40	1650	9.3 kg 0.058 m3 2 szt.	
	<b>ZW598</b>	<b>1255,-</b>	590	40	1850	9.4 kg 0.064 m3 2 szt.	
	<b>ZW692</b>	<b>1020,-</b>	690	40	1250	7.8 kg 0.052 m3 2 szt.	
	<b>ZW694</b>	<b>1135,-</b>	690	40	1450	8.7 kg 0.059 m3 2 szt.	
	<b>ZW696</b>	<b>1255,-</b>	690	40	1650	9.7 kg 0.066 m3 2 szt.	
	<b>ZW698</b>	<b>1370,-</b>	690	40	1850	10.4 kg 0.073 m3 2 szt.	
	<b>ZW792</b>	<b>1105,-</b>	790	40	1250	8.7 kg 0.058 m3 2 szt.	
	<b>ZW794</b>	<b>1240,-</b>	790	40	1450	9.4 kg 0.066 m3 2 szt.	
	<b>ZW796</b>	<b>1360,-</b>	790	40	1650	11.3 kg 0.074 m3 2 szt.	
	<b>ZW798</b>	<b>1500,-</b>	790	40	1850	12 kg 0.082 m3 2 szt.	
	<b>ZW892</b>	<b>1195,-</b>	890	40	1250	9.2 kg 0.064 m3 2 szt.	
	<b>ZW894</b>	<b>1335,-</b>	890	40	1450	10.8 kg 0.073 m3 2 szt.	
	<b>ZW896</b>	<b>1485,-</b>	890	40	1650	11 kg 0.082 m3 2 szt.	
	<b>ZW898</b>	<b>1620,-</b>	890	40	1850	11.2 kg 0.091 m3 2 szt.	

Dodatkowa dopłata							
II grupa cenowa	III grupa cenowa	IV grupa cenowa	Stopa na kółkach				
144,-	342,-	480,-	206,-				
168,-	394,-	570,-	206,-				
188,-	438,-	630,-	206,-				
208,-	490,-	705,-	206,-				
144,-	342,-	480,-	206,-				
168,-	394,-	570,-	206,-				
188,-	438,-	630,-	206,-				
208,-	490,-	705,-	206,-				
288,-	685,-	960,-	206,-				
332,-	775,-	1120,-	206,-				
374,-	885,-	1275,-	206,-				
414,-	980,-	1440,-	206,-				
288,-	685,-	960,-	206,-				
332,-	775,-	1120,-	206,-				
374,-	885,-	1275,-	206,-				
414,-	980,-	1440,-	206,-				

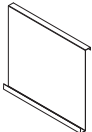
Panele wolnostojące							
	Symbol	Cena netto PLN	Wymiary			Waga Obj. Opak.	Uwagi
			Szer.	Gł.	Wys.		
	<b>ZW992</b>	<b>1280,-</b>	990	40	1250	11.7 kg 0.075 m3 3 szt.	
	<b>ZW994</b>	<b>1445,-</b>	990	40	1450	12.5 kg 0.085 m3 3 szt.	
	<b>ZW996</b>	<b>1590,-</b>	990	40	1650	13.8 kg 0.095 m3 3 szt.	
	<b>ZW998</b>	<b>1745,-</b>	990	40	1850	15.8 kg 0.105 m3 3 szt.	
Łączniki do paneli wolnostojących Sonic							
	<b>ZW5</b>	<b>82,-</b>	150	37 36.5	50	0.37 kg 0 m3 1 szt.	
	<b>ZW6</b>	<b>98,-</b>	150	116	50	0.37 kg 0.001 m3 1 szt.	
	<b>ZW7</b>	<b>120,-</b>	150	116	50	0.53 kg 0.001 m3 1 szt.	
	<b>ZW8</b>	<b>160,-</b>	150	190 189.5	50	0.69 kg 0.001 m3 1 szt.	
Akcesoria							
	<b>TB01</b>	<b>410,-</b>	700	92	635	4.5 kg 0.046 m3 1 szt.	tablica magnetyczna - suchościerna

Dodatkowa dopłata							
II grupa cenowa	III grupa cenowa	IV grupa cenowa	Stopa na kółkach				
288,-	685,-	960,-	206,-				
332,-	775,-	1120,-	206,-				
374,-	885,-	1275,-	206,-				
414,-	980,-	1440,-	206,-				

Zestawienie kolorystyczne - Viva - panel wolnostojący

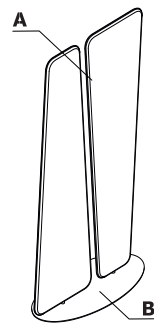

Materiał	Kolor	Panel wolnostojący															
		A - Panel	B - Stelaż														
Tkanina	Nemo	✓															
	Runner	II grupa ✓															
	Medley	II grupa ✓															
	**Atlantic	II grupa ✓															
	Vita	II grupa ✓															
	Mica	II grupa ✓															
	Go Check	II grupa ✓															
	****Charles	II grupa ✓															
	*Tkanina powierzona	II grupa ✓															
	Synergy	III grupa ✓															
	***Silvertex	III grupa ✓															
	Tessa	III grupa ✓															
	Oceanic	III grupa ✓															
	Quest	III grupa ✓															
	Grain	III grupa ✓															
	Atlas	IV grupa ✓															

\* Zastosowanie tkaniny powierzonej wymaga przeprowadzenia prób tapicerskich, w celu sprawdzenia możliwości wykonawczych

\*\* Istnieje możliwość zamówienia produktu w pełnej kolorystyce Atlantic wg wzornika Gabriel w terminie nie krótszym niż 7 tygodni

\*\*\* Istnieje możliwość zamówienia produktu w pełnej kolorystyce Silvertex wg wzornika Spradling w terminie nie krótszym niż 15 dni roboczych

\*\*\*\* Istnieje możliwość zamówienia produktu w pełnej kolorystyce Charles wg wzornika Dekoma w standardowym terminie realizacji.

Materiał	Kolor	Panel wolnostojący													
		A - Panel	B - Stelaż												
Metal	M009 - aluminium półmat RAL 9006		✓												
	M015 - biały półmat RAL 9010		✓												
	M115 - czarny półmat RAL 9005		✓												
	M154 - antracyt półmat RAL 7043		✓												

**Panel wolnostojący**

- 1 **Panel** - tapicerowany, konstrukcja wykonana w technologii paneli Sonic, posiadających certyfikat akustyczności klasy A, możliwość wpinania szpilek
- 2 **Zamek błyskawiczny** - ozdobny, bez możliwości odpinania, kolor: grafit
- 3 **Rama** - rura stalowa
- 4 **Wypełnienie** - włóknina akustyczna o wysokim stopniu pochłaniania i rozpraszania dźwięków
- 5 **Stopa metalowa** - metal malowany proszkowo
- 6 **Obrót 360°** - każdy z paneli obraca się niezależnie

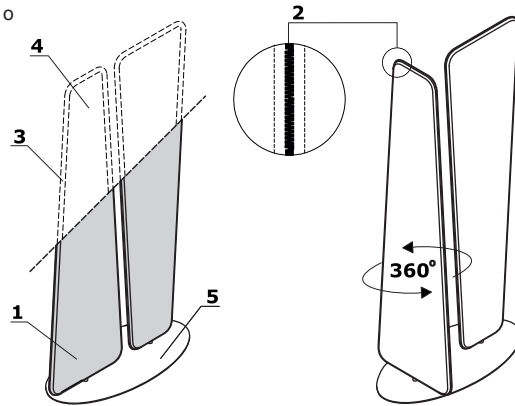

**Wymiary (mm)**

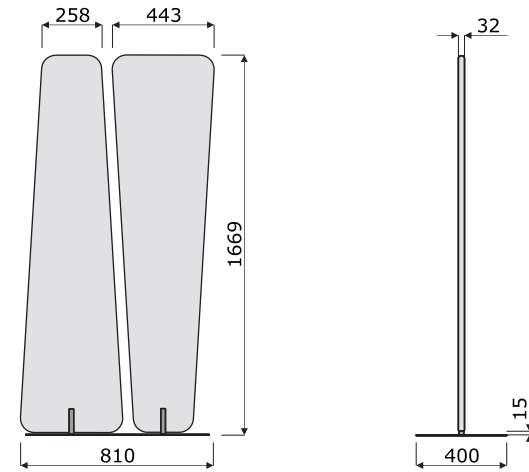

**Panel wolnostojący**

	Symbol	Cena netto PLN	Wymiary			Waga Obj. Opak.	Uwagi
			Szer.	Gł.	Wys.		
	<b>VV02</b>	<b>2060,-</b>	850	400	1670	22.9 kg 0.084 m3 3 szt.	

Dodatkowa dopłata						
II grupa cenowa	III grupa cenowa	IV grupa cenowa				
188,-	448,-	650,-				

Zestawienie kolorystyczne - Sonic - panele ściienne i sufitowe

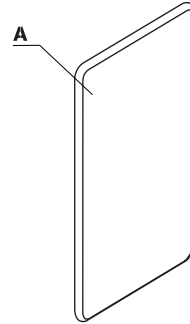

Materiał	Kolor	Panele														
		A - Panel														
Tkanina	Nemo	✓														
	Runner	II grupa ✓														
	Medley	II grupa ✓														
	**Atlantic	II grupa ✓														
	Vita	II grupa ✓														
	Mica	II grupa ✓														
	Go Check	II grupa ✓														
	****Charles	II grupa ✓														
	*Tkanina powierzona	II grupa ✓														
	Synergy	III grupa ✓														
	***Silvertex	III grupa ✓														
	Tessa	III grupa ✓														
	Oceanic	III grupa ✓														
	Quest	III grupa ✓														
	Grain	III grupa ✓														
	Atlas	IV grupa ✓														

\* Zastosowanie tkaniny powierzonej wymaga przeprowadzenia prób tapicerskich, w celu sprawdzenia możliwości wykonawczych

\*\* Istnieje możliwość zamówienia produktu w pełnej kolorystyce Atlantic wg wzornika Gabriel w terminie nie krótszym niż 7 tygodni

\*\*\* Istnieje możliwość zamówienia produktu w pełnej kolorystyce Silvertex wg wzornika Spradling w terminie nie krótszym niż 15 dni roboczych

\*\*\*\* Istnieje możliwość zamówienia produktu w pełnej kolorystyce Charles wg wzornika Dekoma w standardowym terminie realizacji.

**Sonic - panele akustyczne ściennie**

- 1 Panel** - tapicerowany jednostronnie, konstrukcja wykonana w technologii paneli Sonic, posiadających certyfikat akustyczności klasy A, możliwość wpinania szpilek
- 2 Rama** - konstrukcja z litego drewna klejonego
- 3 Wypełnienie** - włóknina akustyczna o wysokim stopniu pochłaniania i rozpraszania dźwięków
- 4 Zawieszka** - do mocowania na ścianie (w komplecie kołki do mocowania do ścian pełnych i z płyt gipsowo - kartonowych)

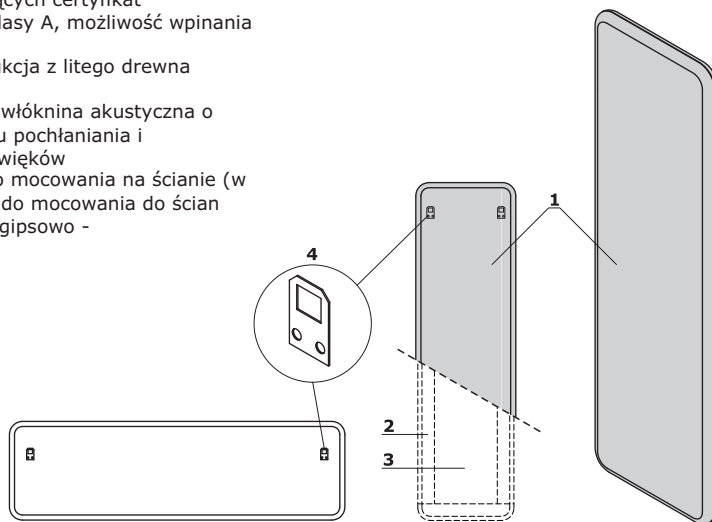
**Sonic - panele akustyczne sufitowe**

- 1 Panele sufitowe (mocowane pionowo)** - konstrukcja wykonana w technologii paneli Sonic, posiadających certyfikat akustyczności klasy A
- 2 Panele sufitowe (mocowane poziomo)** - tapicerowany jednostronnie, konstrukcja wykonana w technologii paneli Sonic, posiadających certyfikat akustyczności klasy A
- 3 Linka stalowa** - stal nierdzewna, możliwość regulacji długości paneli wiszących pionowo w zakresie 100 - 900 mm oraz paneli wiszących poziomo w zakresie 200 - 1400 mm

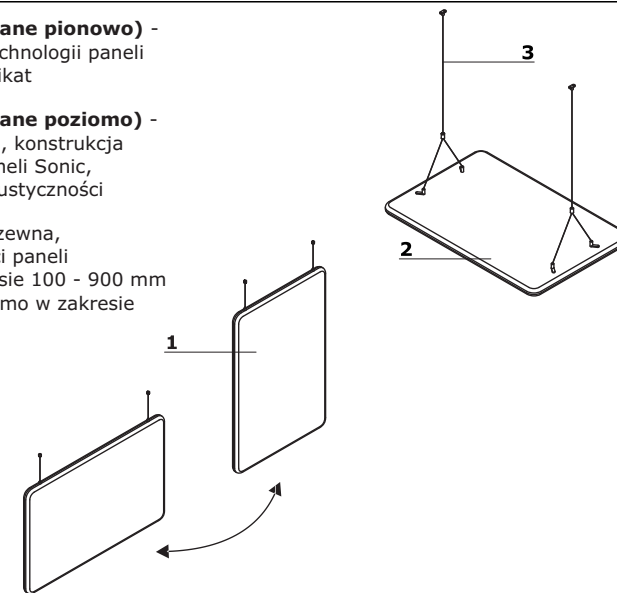
**Sonic - panele sufitowe - szyna do wieszania paneli**

- 1 Szyna** - aluminium, 2szt.
- 2 Mocowanie**

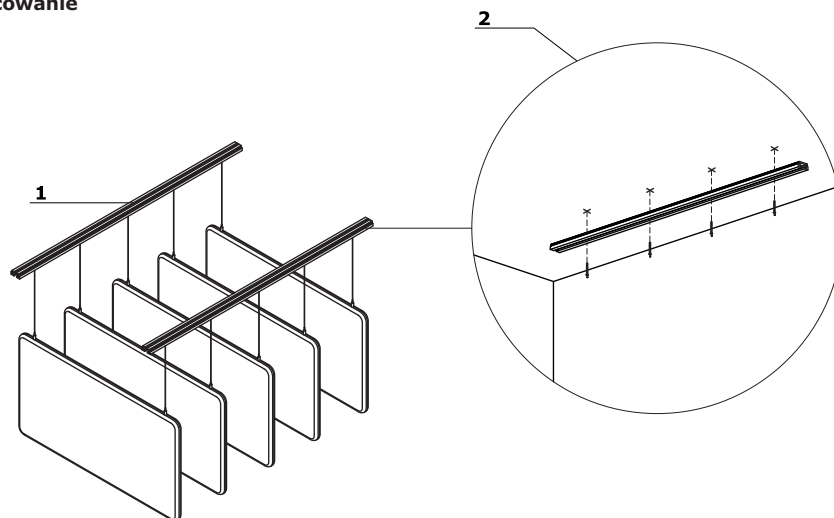

UWAGA - kołki rozporowe do sufitów betonowych z atestem ITB – odporność ogniowa A1.

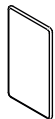
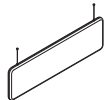
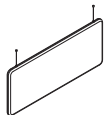
Sonic - panele akustyczne ścienne							
	Symbol	Cena netto PLN	Wymiary			Waga Obj. Opak.	Uwagi
			Szer.	Gł.	Wys.		
	ZAK312	650,-	350	40	1190	4 kg 0.023 m3 1 szt.	montaż poziomo lub pionowo; tapicerowany jednostronnie
	ZAK318	760,-	350	40	1790	6.2 kg 0.034 m3 1 szt.	
	ZAK612	870,-	650	40	1190	5.1 kg 0.041 m3 1 szt.	
	ZAK618	1220,-	650	40	1790	6.9 kg 0.061 m3 1 szt.	
Sonic - panele sufitowe - mocowanie dłuższą krawędzią do sufitu							
	ZUS12G	650,-	1190	40	350	10 kg 0.027 m3 1 szt.	Wyrób bez możliwości Montażu Fabrycznego. Nie wlicza się do kosztów Montażu.
	ZUS14G	690,-	1390	40	350	4.3 kg 0.031 m3 1 szt.	
	ZUS16G	725,-	1590	40	350	10 kg 0.036 m3 1 szt.	
	ZUS18G	770,-	1790	40	350	10 kg 0.04 m3 1 szt.	
	ZUS20G	820,-	1990	40	350	10 kg 0.045 m3 1 szt.	
Sonic - panele sufitowe - mocowanie dłuższą lub krótszą krawędzią do sufitu							
	ZUS05G	745,-	990	40	500	10 kg 0.032 m3 1 szt.	Wyrób bez możliwości Montażu Fabrycznego. Nie wlicza się do kosztów Montażu.
	ZUS52G	795,-	1190	40	500	10 kg 0.038 m3 1 szt.	
	ZUS54G	845,-	1390	40	500	10 kg 0.044 m3 1 szt.	
	ZUS56G	890,-	1590	40	500	10 kg 0.05 m3 1 szt.	
	ZUS58G	940,-	1790	40	500	10 kg 0.056 m3 1 szt.	
	ZUS59G	1000,-	1990	40	500	10 kg 0.063 m3 1 szt.	

Dodatkowa dopłata									
II grupa cenowa	III grupa cenowa	IV grupa cenowa							
74,-	178,-	250,-							
94,-	230,-	320,-							
144,-	352,-	500,-							
208,-	500,-	715,-							
134,-	320,-	448,-							
154,-	362,-	510,-							
178,-	414,-	600,-							
198,-	468,-	675,-							
220,-	510,-	735,-							
124,-	274,-	384,-							
134,-	320,-	448,-							
154,-	362,-	510,-							
178,-	414,-	600,-							
198,-	468,-	675,-							
220,-	510,-	735,-							



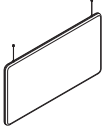
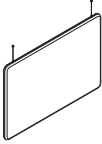

Sonic - panele sufitowe - mocowanie dłuższą lub krótszą krawędzią do sufitu							
	Symbol	Cena netto PLN	Wymiary			Waga Obj. Opak.	Uwagi
			Szer.	Gł.	Wys.		
	<b>ZPS610G</b>	<b>870,-</b>	990	40	650	10 kg 0.041 m3 1 szt.	Wyrób bez możliwości Montażu Fabrycznego. Nie wlicza się do kosztów Montażu.
	<b>ZPS612G</b>	<b>920,-</b>	1190	40	650	10 kg 0.049 m3 1 szt.	
	<b>ZPS614G</b>	<b>970,-</b>	1390	40	650	10 kg 0.057 m3 1 szt.	
	<b>ZPS616G</b>	<b>1015,-</b>	1590	40	650	10 kg 0.065 m3 1 szt.	
	<b>ZPS618G</b>	<b>1065,-</b>	1790	40	650	10 kg 0.073 m3 1 szt.	
	<b>ZPS620G</b>	<b>1125,-</b>	1990	40	650	10 kg 0.081 m3 1 szt.	
		<b>ZPS810G</b>	<b>920,-</b>	990	40	800	
<b>ZPS812G</b>		<b>970,-</b>	1190	40	800	10 kg 0.06 m3 1 szt.	
<b>ZPS814G</b>		<b>1055,-</b>	1390	40	800	10 kg 0.069 m3 1 szt.	
<b>ZPS816G</b>		<b>1130,-</b>	1590	40	800	10 kg 0.079 m3 1 szt.	
<b>ZPS818G</b>		<b>1215,-</b>	1790	40	800	10 kg 0.089 m3 1 szt.	
<b>ZPS820G</b>		<b>1285,-</b>	1990	40	800	10 kg 0.099 m3 1 szt.	

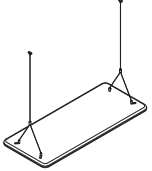
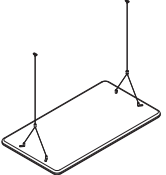
Dodatkowa dopłata						
II grupa cenowa	III grupa cenowa	IV grupa cenowa				
124,-	274,-	384,-				
134,-	320,-	448,-				
154,-	362,-	510,-				
178,-	414,-	600,-				
198,-	468,-	675,-				
220,-	510,-	735,-				
240,-	550,-	765,-				
260,-	630,-	885,-				
308,-	725,-	1020,-				
352,-	825,-	1170,-				
384,-	920,-	1330,-				
426,-	1020,-	1490,-				

Sonic - panele sufitowe - mocowane poziomo							
	Symbol	Cena netto PLN	Wymiary			Waga Obj. Opak.	Uwagi
			Szer.	Gł.	Wys.		
	<b>ZUS05GP</b>	<b>675,-</b>	990	40	500	10 kg 0.032 m3 1 szt.	Wyrób bez możliwości Montażu Fabrycznego. Nie wlicza się do kosztów Montażu.
	<b>ZUS52GP</b>	<b>715,-</b>	1190	40	500	10 kg 0.038 m3 1 szt.	
	<b>ZUS54GP</b>	<b>760,-</b>	1390	40	500	10 kg 0.044 m3 1 szt.	
	<b>ZUS56GP</b>	<b>805,-</b>	1590	40	500	10 kg 0.05 m3 1 szt.	
	<b>ZUS58GP</b>	<b>845,-</b>	1790	40	500	10 kg 0.056 m3 1 szt.	
	<b>ZUS59GP</b>	<b>900,-</b>	1990	40	500	10 kg 0.063 m3 1 szt.	
		<b>ZPS610GP</b>	<b>780,-</b>	990	40	650	
<b>ZPS612GP</b>		<b>825,-</b>	1190	40	650	10 kg 0.049 m3 1 szt.	
<b>ZPS614GP</b>		<b>870,-</b>	1390	40	650	5.7 kg 0.057 m3 1 szt.	
<b>ZPS616GP</b>		<b>920,-</b>	1590	40	650	6 kg 0.065 m3 1 szt.	
<b>ZPS618GP</b>		<b>960,-</b>	1790	40	650	10 kg 0.073 m3 1 szt.	
<b>ZPS620GP</b>		<b>1010,-</b>	1990	40	650	10 kg 0.081 m3 1 szt.	

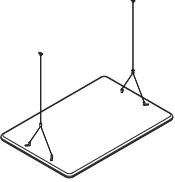
Dodatkowa dopłata						
II grupa cenowa	III grupa cenowa	IV grupa cenowa				
124,-	274,-	384,-				
134,-	320,-	448,-				
154,-	362,-	510,-				
178,-	414,-	600,-				
198,-	468,-	675,-				
220,-	510,-	735,-				
124,-	274,-	384,-				
134,-	320,-	448,-				
154,-	362,-	510,-				
178,-	414,-	600,-				
198,-	468,-	675,-				
220,-	510,-	735,-				

Sonic - panele sufitowe - mocowane poziomo							
	Symbol	Cena netto PLN	Wymiary			Waga Obj. Opak.	Uwagi
			Szer.	Gł.	Wys.		
	<b>ZPS810GP</b>	<b>825,-</b>	990	40	800	10 kg 0.05 m3 1 szt.	Wyrób bez możliwości Montażu Fabrycznego. Nie wlicza się do kosztów Montażu.
	<b>ZPS812GP</b>	<b>870,-</b>	1190	40	800	5.4 kg 0.06 m3 1 szt.	
	<b>ZPS814GP</b>	<b>950,-</b>	1390	40	800	10 kg 0.069 m3 1 szt.	
	<b>ZPS816GP</b>	<b>1015,-</b>	1590	40	800	10 kg 0.079 m3 1 szt.	
	<b>ZPS818GP</b>	<b>1095,-</b>	1790	40	800	7.5 kg 0.089 m3 1 szt.	
	<b>ZPS820GP</b>	<b>1155,-</b>	1990	40	800	10 kg 0.099 m3 1 szt.	
	<b>Akcesoria</b>						
	<b>ZSZ200</b>	<b>480,-</b>	2000	30	30	0 kg 0 m3 0 szt.	szyna do wieszania paneli sufitowych (2 szt.)

Dodatkowa dopłata							
II grupa cenowa	III grupa cenowa	IV grupa cenowa					
115,-	265,-	380,-					
125,-	315,-	440,-					
145,-	355,-	505,-					
170,-	400,-	565,-					
190,-	450,-	630,-					
210,-	495,-	695,-					

Zestawienie kolorystyczne - Bazalto - panele ścienne

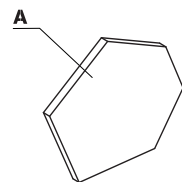

Materiał	Kolor	Panele															
		A - Panel															
Tkanina	Nemo	✓															
	Runner	II grupa ✓															
	Medley	II grupa ✓															
	**Atlantic	II grupa ✓															
	Vita	II grupa ✓															
	Mica	II grupa ✓															
	Go Check	II grupa ✓															
	****Charles	II grupa ✓															
	Synergy	III grupa ✓															
	***Silvertex	III grupa ✓															
	Tessa	III grupa ✓															
	Oceanic	III grupa ✓															
	Quest	III grupa ✓															
	Grain	III grupa ✓															
	*Tkanina powierzona	II grupa ✓															
	Atlas	IV grupa ✓															

\* Zastosowanie tkaniny powierzonej wymaga przeprowadzenia prób tapicerskich, w celu sprawdzenia możliwości wykonawczych

\*\* Istnieje możliwość zamówienia produktu w pełnej kolorystyce Atlantic wg wzornika Gabriel w terminie nie krótszym niż 7 tygodni

\*\*\* Istnieje możliwość zamówienia produktu w pełnej kolorystyce Silvertex wg wzornika Spradling w terminie nie krótszym niż 15 dni roboczych

\*\*\*\* Istnieje możliwość zamówienia produktu w pełnej kolorystyce Charles wg wzornika Dekoma w standardowym terminie realizacji.

**Bazalto - panele ścienne**

- Panel** - tapicerowany jednostronnie, konstrukcja wykonana w technologii paneli Sonic, posiadających certyfikat akustyczności klasy A, możliwość wpinania szpilek
- Rama** - płyta wiórowa
- Wypełnienie** - włóknina akustyczna o wysokim stopniu pochłaniania i rozpraszania dźwięków
- Mocowanie** - klej (1 opakowanie na 6 szt. paneli) - zamawiany jako oddzielny element (symbol BKL1)

Bazalto - panele ścienne							
	Symbol	Cena netto PLN	Wymiary			Waga Obj. Opak.	Uwagi
			Szer.	Gł.	Wys.		
	<b>BWP1</b>	<b>288,-</b>	650	21	550	1.7 kg 0.01 m3 1 szt.	w przypadku zamawiania paneli konieczność domówienia kleju montażowego BKL1 (zamawiany jako oddzielna pozycja)
	<b>BWP2</b>	<b>342,-</b>	650	39	550	2.3 kg 0.018 m3 1 szt.	
Klej do paneli							
	<b>BKL1</b>	<b>94,-</b>	220	50	50	0.4 kg 0.001 m3 1 szt.	klej do paneli; Bazalto (1 opakowanie na 6 szt. paneli), Mix (1 opakowanie na 6 szt. paneli małych lub 3 duże)

Dodatkowa dopłata						
II grupa cenowa	III grupa cenowa	IV grupa cenowa				
88,-	208,-	308,-				
88,-	208,-	308,-				

Zestawienie kolorystyczne - Mix - panele ścienne i sufitowe

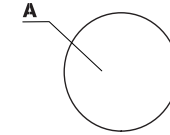
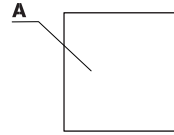

Materiał	Kolor	Panele													
		A - Panel													
Tkanina	Nemo	✓													
	Runner	II grupa ✓													
	Medley	II grupa ✓													
	**Atlantic	II grupa ✓													
	Vita	II grupa ✓													
	Mica	II grupa ✓													
	Go Check	II grupa ✓													
	****Charles	II grupa ✓													
	*Tkanina powierzona	II grupa ✓													
	Synergy	III grupa ✓													
	***Silvertex	III grupa ✓													
	Tessa	III grupa ✓													
	Oceanic	III grupa ✓													
	Quest	III grupa ✓													
	Grain	III grupa ✓													
	Atlas	IV grupa ✓													

\* Zastosowanie tkaniny powierzonej wymaga przeprowadzenia prób tapicerskich, w celu sprawdzenia możliwości wykonawczych  
 \*\* Istnieje możliwość zamówienia produktu w pełnej kolorystyce Atlantic wg wzornika Gabriel w terminie nie krótszym niż 7 tygodni

\*\*\* Istnieje możliwość zamówienia produktu w pełnej kolorystyce Silvertex wg wzornika Spradling w terminie nie krótszym niż 15 dni roboczych  
 \*\*\*\* Istnieje możliwość zamówienia produktu w pełnej kolorystyce Charles wg wzornika Dekoma w standardowym terminie realizacji.

**Mix - panele ściienne i sufitowe**

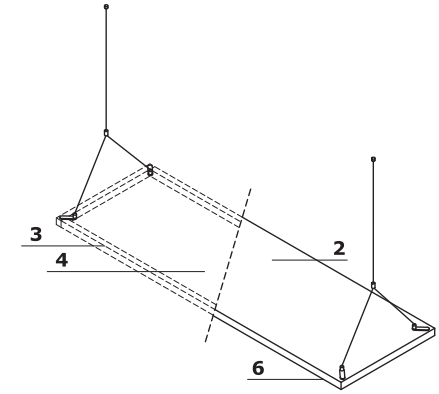
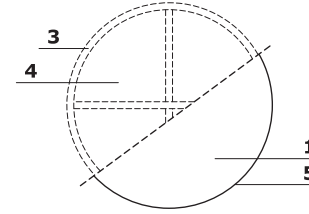
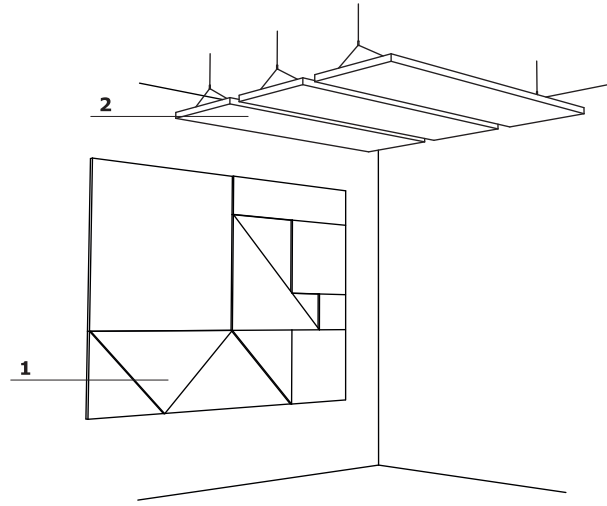

- 1 Panele ściienne** - tapicerowany jednostronnie, konstrukcja wykonana w technologii paneli Sonic, posiadających certyfikat akustyczności klasy A
- 2 Panele sufitowe (mocowane pionowo)** - konstrukcja wykonana w technologii paneli Sonic, posiadających certyfikat akustyczności klasy A
- 3 Rama** - płyta wiórowa
- 4 Wypełnienie** - włóknina akustyczna o wysokim stopniu pochłaniania i rozpraszania dźwięków
- 5 Mocowanie** - klej (1 opakowanie na 6 szt. paneli) - zamawiany jako oddzielny element (symbol BKL1)
- 6 Linka stalowa** - stal nierdzewna, możliwość regulacji długości 200 - 1400 mm





Mix - panele ściennie						
Symbol	Cena netto PLN	Wymiary			Waga Obj. Opak.	Uwagi
		Szer.	Gł.	Wys.		
<b>MX01P</b>	<b>152,-</b>	600	28	300	1.3 kg 0.008 m3 1 szt.	w przypadku zamawiania paneli konieczność domówienia kleju montażowego BKL1 (zamawiany jako oddzielna pozycja)
<b>MX01PG</b>	<b>170,-</b>	600	45	300	1.8 kg 0.012 m3 1 szt.	
<b>MX02P</b>	<b>192,-</b>	900	28	300	1.8 kg 0.012 m3 1 szt.	
<b>MX02PG</b>	<b>208,-</b>	900	45	300	2.5 kg 0.017 m3 1 szt.	
<b>MX03P</b>	<b>232,-</b>	1200	28	300	2.2 kg 0.015 m3 1 szt.	
<b>MX03PG</b>	<b>252,-</b>	1200	45	300	3.4 kg 0.023 m3 1 szt.	
<b>MX08P</b>	<b>515,-</b>	1800	28	600	5.4 kg 0.045 m3 1 szt.	
<b>MX08PG</b>	<b>610,-</b>	1800	45	600	6.9 kg 0.067 m3 1 szt.	
<b>MX09P</b>	<b>660,-</b>	2400	28	600	7.1 kg 0.059 m3 1 szt.	
<b>MX09PG</b>	<b>760,-</b>	2400	45	600	7 kg 0.089 m3 1 szt.	

Dodatkowa dopłata						
II grupa cenowa	III grupa cenowa	IV grupa cenowa				
43,-	98,-	144,-				
43,-	98,-	144,-				
64,-	144,-	198,-				
64,-	144,-	198,-				
78,-	178,-	250,-				
78,-	178,-	250,-				
208,-	500,-	715,-				
208,-	500,-	715,-				
274,-	665,-	930,-				
274,-	665,-	930,-				







Mix - panele ściennie							
	Symbol	Cena netto PLN	Wymiary			Waga Obj. Opak.	Uwagi
			Szer.	Gł.	Wys.		
	<b>MX04P</b>	<b>120,-</b>	300	28	300	0.7 kg 0.004 m3 1 szt.	w przypadku zamawiania paneli konieczność domówienia kleju montażowego BKL1 (zamawiany jako oddzielna pozycja)
	<b>MX04PG</b>	<b>126,-</b>	300	45	300	1.1 kg 0.006 m3 1 szt.	
	<b>MX05P</b>	<b>208,-</b>	600	28	600	2.2 kg 0.014 m3 1 szt.	
	<b>MX05PG</b>	<b>238,-</b>	600	45	600	3 kg 0.018 m3 1 szt.	
	<b>MX06P</b>	<b>372,-</b>	900	28	900	4.7 kg 0.033 m3 1 szt.	
	<b>MX06PG</b>	<b>432,-</b>	900	45	900	6.1 kg 0.05 m3 1 szt.	
	<b>MX07P</b>	<b>515,-</b>	1200	28	1200	7.7 kg 0.059 m3 1 szt.	
	<b>MX07PG</b>	<b>635,-</b>	1200	45	1200	9.7 kg 0.089 m3 1 szt.	
		<b>MX10P</b>	<b>282,-</b>	600	28	600	
<b>MX10PG</b>		<b>322,-</b>	600	45	600	2.3 kg 0.018 m3 1 szt.	
<b>MX11P</b>		<b>482,-</b>	900	28	900	3.7 kg 0.033 m3 1 szt.	
<b>MX11PG</b>		<b>550,-</b>	900	45	900	5.2 kg 0.05 m3 1 szt.	
<b>MX12P</b>		<b>680,-</b>	1200	28	1200	5.9 kg 0.059 m3 1 szt.	
<b>MX12PG</b>		<b>790,-</b>	1200	45	1200	8.4 kg 0.089 m3 1 szt.	

Dodatkowa dopłata						
II grupa cenowa	III grupa cenowa	IV grupa cenowa				
28,-	68,-	88,-				
28,-	68,-	88,-				
43,-	98,-	144,-				
43,-	98,-	144,-				
124,-	274,-	394,-				
124,-	274,-	394,-				
144,-	332,-	468,-				
144,-	332,-	468,-				
43,-	98,-	144,-				
43,-	98,-	144,-				
124,-	274,-	394,-				
124,-	274,-	394,-				
144,-	332,-	468,-				
144,-	332,-	468,-				

Mix - panele ściennie								
	Symbol	Cena netto PLN	Wymiary			Waga Obj. Opak.	Uwagi	
			Szer.	Gł.	Wys.			
	<b>MX13P</b>	<b>170,-</b>	600	28	600	1.4 kg 0.011 m3 1 szt.	w przypadku zamawiania paneli konieczność domówienia kleju montażowego BKL1 (zamawiany jako oddzielna pozycja)	
	<b>MX13PG</b>	<b>192,-</b>	600	45	600	1.9 kg 0.016 m3 1 szt.		
	<b>MX14P</b>	<b>298,-</b>	900	28	900	2.6 kg 0.024 m3 1 szt.		
	<b>MX14PG</b>	<b>348,-</b>	900	45	900	3.4 kg 0.036 m3 1 szt.		
	<b>MX15P</b>	<b>414,-</b>	1200	28	1200	8.7 kg 0.042 m3 1 szt.		
	<b>MX15PG</b>	<b>505,-</b>	1200	45	1200	5.2 kg 0.063 m3 1 szt.		
	<b>MX16P</b>	<b>170,-</b>	900	28	450	1.7 kg 0.017 m3 1 szt.		w przypadku zamawiania paneli konieczność domówienia kleju montażowego BKL1 (zamawiany jako oddzielna pozycja)
	<b>MX16PG</b>	<b>192,-</b>	900	45	450	2.2 kg 0.026 m3 1 szt.		
	<b>MX17P</b>	<b>298,-</b>	1200	28	600	2.5 kg 0.03 m3 1 szt.		
	<b>MX17PG</b>	<b>348,-</b>	1200	45	600	3.5 kg 0.045 m3 1 szt.		

Dodatkowa dopłata						
II grupa cenowa	III grupa cenowa	IV grupa cenowa				
43,-	98,-	144,-				
43,-	98,-	144,-				
124,-	274,-	394,-				
124,-	274,-	394,-				
144,-	332,-	468,-				
144,-	332,-	468,-				
64,-	144,-	198,-				
64,-	144,-	198,-				
74,-	168,-	230,-				
74,-	168,-	230,-				

Mix - panele sufitowe							
	Symbol	Cena netto PLN	Wymiary			Waga Obj. Opak.	Uwagi
			Szer.	Gł.	Wys.		
	<b>MX06S</b>	<b>540,-</b>	900	45	900	6.5 kg 0.05 m3 1 szt.	Wyrób bez możliwości Montażu Fabrycznego. Nie wlicza się do kosztów Montażu.
	<b>MX07S</b>	<b>735,-</b>	1200	45	1200	6.4 kg 0.089 m3 1 szt.	Wyrób bez możliwości Montażu Fabrycznego. Nie wlicza się do kosztów Montażu.
	<b>MX08S</b>	<b>715,-</b>	1800	45	600	7.4 kg 0.067 m3 1 szt.	Wyrób bez możliwości Montażu Fabrycznego. Nie wlicza się do kosztów Montażu.
	<b>MX09S</b>	<b>875,-</b>	2400	45	600	8 kg 0.089 m3 1 szt.	Wyrób bez możliwości Montażu Fabrycznego. Nie wlicza się do kosztów Montażu.
	<b>MX11S</b>	<b>650,-</b>	900	45	900	5.5 kg 0.05 m3 1 szt.	Wyrób bez możliwości Montażu Fabrycznego. Nie wlicza się do kosztów Montażu.
	<b>MX12S</b>	<b>895,-</b>	1200	45	1200	8.6 kg 0.089 m3 1 szt.	Wyrób bez możliwości Montażu Fabrycznego. Nie wlicza się do kosztów Montażu.
	<b>MX14S</b>	<b>432,-</b>	900	45	900	3.4 kg 0.036 m3 1 szt.	Wyrób bez możliwości Montażu Fabrycznego. Nie wlicza się do kosztów Montażu.
	<b>MX15S</b>	<b>595,-</b>	1200	45	1200	5.6 kg 0.063 m3 1 szt.	Wyrób bez możliwości Montażu Fabrycznego. Nie wlicza się do kosztów Montażu.
Klej do paneli							
	<b>BKL1</b>	<b>94,-</b>	220	50	50	0.4 kg 0.001 m3 1 szt.	klej do paneli; Bazalto (1 opakowanie na 6 szt. paneli), Mix (1 opakowanie na 6 szt. paneli małych lub 3 duże)

Dodatkowa dopłata						
II grupa cenowa	III grupa cenowa	IV grupa cenowa				
124,-	274,-	394,-				
144,-	332,-	468,-				
208,-	500,-	715,-				
274,-	665,-	930,-				
124,-	274,-	394,-				
144,-	332,-	468,-				
124,-	274,-	394,-				
144,-	332,-	468,-				

**Zestawienie kolorystyczne - Osłony przednie do biurek**

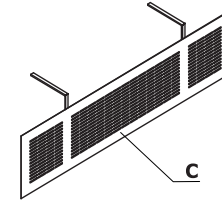
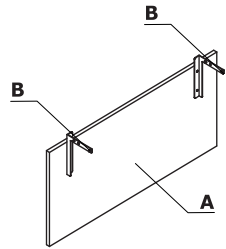

Materiał	Kolor	Osłony płytowe do biurek														
		A - Osłona płytowa	B - Uchwyt - osłona płytowa	C - Osłona rastrowa												
Płyta	26 - aluminium satinato	✓														
	31 - dąb kanadyjski	✓														
	39 - brzoza polarna	✓														
	64 - kakao	✓														
	67 - biały pastel	✓														
	106 - orzech nizinny	✓														
	154 - antracyt	✓														
	08 - czarny	✓														
	167 - dąb szary	✓														
	168 - dąb naturalny	✓														
	169 - dąb miodowy	✓														
	170 - akacja	✓														
	171 - orzech ciemny	✓														
	174 - beżowy mat	✓														
Metal	M009 - aluminium półmat RAL 9006		✓	✓												
	M015 - biały półmat RAL 9010		✓	✓												
	M115 - czarny półmat RAL 9005		✓	✓												
	M154 - antracyt półmat RAL 7043		✓	✓												

## Osłony do biurtek

- 1 Osłona płytowa** - płyta melaminowana 18 mm, w wyposażeniu kątowniki do mocowania:
- A. uchwyt uniwersalny
  - B. uchwyt wzmacniony - zalecany do biurtek z elektryczną regulacją wysokości; mocowany wyłącznie przy krawędzi blatu
- 2 Osłona rastrowa** - metal malowany proszkowo, w wyposażeniu kątowniki do mocowania

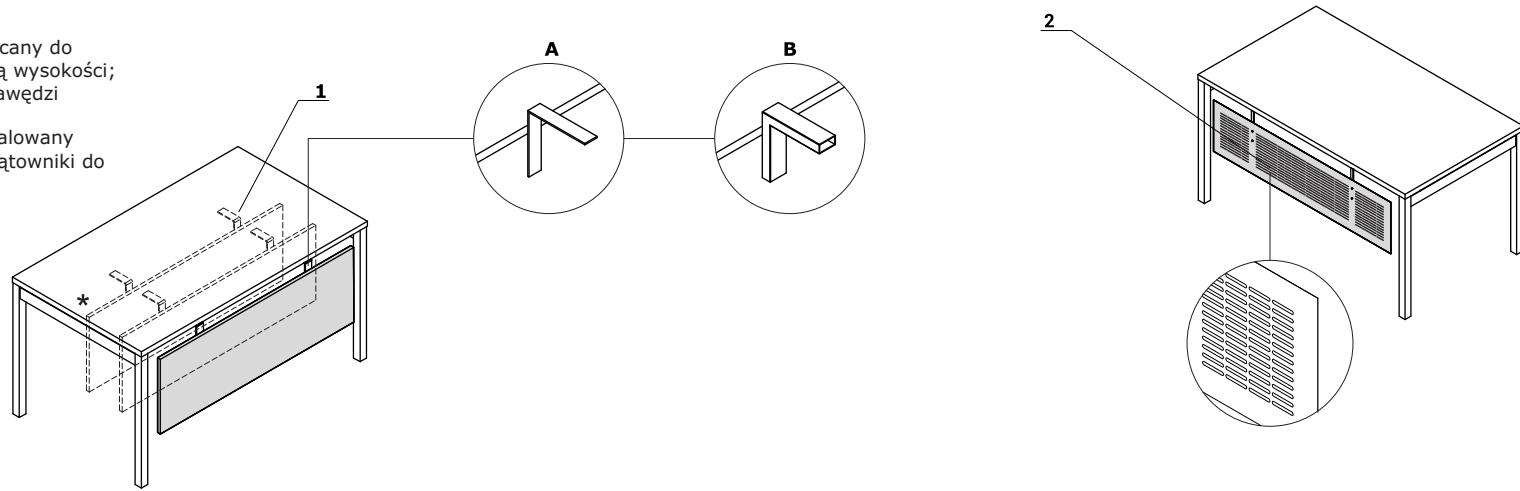

\* możliwość mocowania osłony w dowolnym miejscu tylko w przypadku uchwytu uniwersalnego

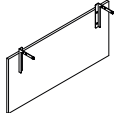
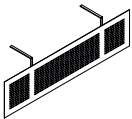
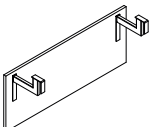



Osłony przednie do biurek - płytowe							
	Symbol	Cena netto PLN	Wymiary			Waga Obj. Opak.	Uwagi
			Szer.	Gł.	Wys.		
	UM10	272,-	1000	18	400	8 kg 0.017 m3 2 szt.	do biurek o szer. 1200mm
	UM12	306,-	1200	18	400	10 kg 0.02 m3 2 szt.	do biurek o szer. 1400mm
	UM14	334,-	1400	18	400	10 kg 0.023 m3 2 szt.	do biurek o szer. 1600mm
	UM16	356,-	1600	18	400	10.55 kg 0.026 m3 2 szt.	do biurek o szer. 1800mm
	UM18	378,-	1800	18	400	12.7 kg 0.029 m3 2 szt.	do biurek o szer. 2000mm
	<b>Osłony przednie do biurek - rastrowe</b>						
	UR14	545,-	1200	15	300	2.8 kg 0.008 m3 1 szt.	do biurka 1400mm
	UR15	570,-	1400	15	300	3.1 kg 0.009 m3 1 szt.	do biurka 1600mm
	UR16	595,-	1600	15	300	3.5 kg 0.01 m3 1 szt.	do biurka 1800mm
<b>Osłony przednie do biurek z opcją blatu przesuwnego</b>							
	UM10S	378,-	1000	18	400	8 kg 0.017 m3 2 szt.	do biurek o szer. 1200mm
	UM12S	406,-	1200	18	400	8.05 kg 0.019 m3 2 szt.	do biurek o szer. 1400mm
	UM14S	434,-	1400	18	400	9.8 kg 0.021 m3 2 szt.	do biurek o szer. 1600mm
	UM16S	456,-	1600	18	400	10.05 kg 0.023 m3 2 szt.	do biurek o szer. 1800mm
	UM18S	482,-	1800	18	400	12.3 kg 0.025 m3 2 szt.	do biurek o szer. 2000mm

Dodatkowa dopłata

## Płyta

 08 - czarny	 26 - aluminium satinato	 31 - dąb kanadyjski	 39 - brzoza polarna	 64 - kakao	 67 - biały pastel	 106 - orzech nizinny	 154 - antracyt
 167 - dąb szary	 168 - dąb naturalny	 169 - dąb miodowy	 170 - akacja	 171 - orzech ciemny	 174 - beżowy mat		









## Metal

 M009 - aluminium półmat RAL 9006	 M015 - biały półmat RAL 9010	 M115 - czarny półmat RAL 9005	 M154 - antracyt półmat RAL 7043
--------------------------------------------------------------------------------------------------------------------------	----------------------------------------------------------------------------------------------------------------------	-----------------------------------------------------------------------------------------------------------------------	--------------------------------------------------------------------------------------------------------------------------

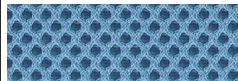
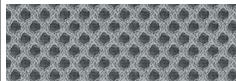
## Tkanina Nemo - I grupa cenowa

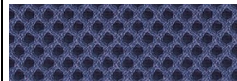
 NE-1 - beżowy	 NE-2 - żółty	 NE-3 - pomarańczowy	 NE-5 - czerwony	 NE-9 - zielony	 NE-10 - szary	 NE-14 - grafitowy	 NE-15 - granatowy
 NE-16 - czarny	 NE-17 - niebieski						

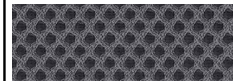
## Tkanina Runner - II grupa cenowa









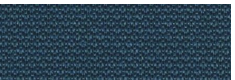

 R-63034 - pomarańczowy	 R-64089 - czerwony	 R-66063 - niebieski	 R-60011 - szary	 R-68056 - zielony	 R-66064 - granatowy	 R-60999 - czarny	 R-60025 - grafitowy
 R-61128 - beżowy	 R-68110 - Ciemny zielony						















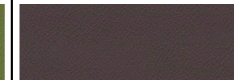

### Tkanina Medley - II grupa cenowa

 M-66008 - szary	 M-60003 - jasny szary	 M-61189 - beżowy	 M-68005 - ciemny oliwkowy	 M-62002 - żółty	 M-62054 - musztardowy	 M-63017 - rdzawy	 M-64019 - czerwony
 M-63064 - różowy	 M-65011 - szarofioletowy	 M-66010 - niebieski	 M-67006 - jasny niebieski	 M-60999 - czarny			

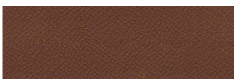

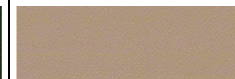

### Tkanina Atlantic - II grupa cenowa (Pozostałe kolory Atlantic wg wzornika Gabriel dostępne w terminie nie krótszym niż 7 dni roboczych)

 A-67043 - ciemny turkusowy	 A-67030 - morski	 A-60141 - jasny szary	 A-60011 - szary	 A-66064 - granatowy	 A-65037 - fioletowy	 A-62048 - oliwkowy	 A-64089 - czerwony
 A-61078 - beżowy	 A-60025 - grafitowy						

### Tkanina Vita - II grupa cenowa

 V-01 - jasny szary	 V-02 - beżowy	 V-03 - żółty	 V-04 - szary	 V-07 - ciemny szary	 V-09 - oliwkowy	 V-10 - szarobrązowy	 V-11 - rdzawy
 V-12 - czarny	 V-39 - czekoladowy	 V-18 - morski	 V-19 - niebieski	 V-29 - ciemny zielony	 V-44 - beżowy	 V-46 - brązowy	

### Tkanina Go check - II grupa cenowa













 G-66136 - niebieski	 G-66135 - jasny niebieski	 G-60080 - ciemny szary	 G-66138 - granatowy	 G-60084 - ciemny grafitowy	 G-68149 - ciemny zielony	 G-68152 - zielony	 G-60079 - szary
 G-64183 - marsala	 G-63079 - pomarańczowy	 G-64171 - czerwony	 G-64172 - bordowy	 G-61144 - brązowy	 G-61145 - ciemny brązowy		

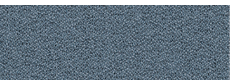



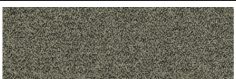
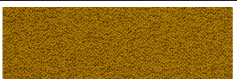

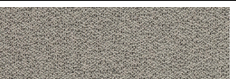
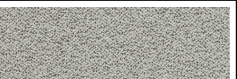
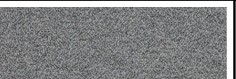
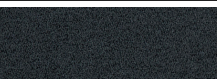
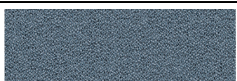
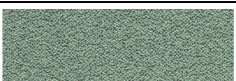
**Tkanina Charles - II grupa cenowa ( Istnieje możliwość zamówienia produktu w pełnej kolorystyce Charles wg wzornika Dekoma w standardowym terminie realizacji. )**

 C-01 - czarny	 C-05 - szary	 C-06 - beżowy	 C-14 - brązowy	 C-18 - rdzawy	 C-21 - czerwony	 C-30 - różowy	 C-31 - marsala
 C-32 - niebieski ciemny	 C-35 - niebieski	 C-41 - żółty	 C-44 - oliwkowy	 C-45 - zielony			

**Tkanina Mica - II grupa cenowa**

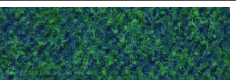
 MC-2496-64183 - różowy	 MC-2496-64146 - czerwony	 MC-2497-64146 - ciemny czerwony	 MC-2497-66006 - granatowy	 MC-2496-66030 - niebieski	 MC-2497-67042 - morski	 MC-2497-67017 - zielony butelkowy	 MC-2497-68146 - zielony
 MC-2497-62048 - oliwkowy	 MC-2496-62093 - jasny oliwkowy	 MC-2496-62095 - musztardowy	 MC-2496-62096 - żółty	 MC-2496-61008 - beżowy	 MC-2496-60000 - jasny szary	 MC-2497-60000 - szary	 MC-2497-60021 - grafitowy
 MC-2496-66031 - niebieski jasny	 MC-2496-67015 - miętowy	 MC-2497-64029 - bordowy					



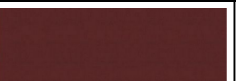



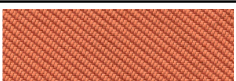
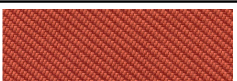

**Tkanina Synergy - III grupa cenowa**

 LDS08 - szary melanz	 LDS20 - jasny szary	 LDS27 - czarny	 LDS29 - ciemny szary	 LDS50 - ciemny zielony	 LDS57 - turkusowy	 LDS60 - zielony butelkowy	 LDS61 - śliwkowy
 LDS69 - granatowy	 LDS84 - pomarańczowy	 LDS86 - czerwony	 LDS88 - oberżyna	 LDS19 - beżowy	 LDS44 - żółty	 LDS79 - brązowy	

### Tkanina Tessa - III grupa cenowa

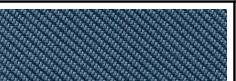
				
T-08 - kremowy	T-09 - beżowy	T-05 - szary	T-03 - ciemny szary	T-02 - grafitowy

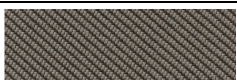
### Tkanina Oceanic - III grupa cenowa











							
O-16 - różowy	O-05 - koralowy	O-12 - czerwony	O-07 - żółty	O-04 - jasny zielony	O-15 - jasny niebieski	O-11 - niebieski	O-13 - jasny szary
							
O-08 - ciemny szary	O-01 - czarny						

### Tkanina Quest - III grupa cenowa

							
Q-26 - różowy	Q-25 - pomarańczowy	Q-24 - czerwony	Q-21 - pastelowy żółty	Q-19 - beżowy	Q-18 - oliwkowy	Q-13 - jasny zielony	Q-07 - jasny niebieski
							
Q-08 - granatowy	Q-04 - grafitowy						

**Tkanina Silvertex - III grupa cenowa - Istnieje możliwość zamówienia produktu w pełnej kolorystyce Silvertex wg wzornika Spradling w terminie nie krótszym niż 15 dni roboczych.**

### Tkanina Grain - III grupa cenowa

 GR-64249 - różowy	 GR-62122 - żółty	 GR-62016 - jasny pomarańczowy	 GR-63117 - pomarańczowy	 GR-68243 - oliwkowy	 GR-66236 - błękitny	 GR-66232 - granatowy	 GR-60301 - szary
 GR-61252 - beżowy	 GR-61250 - biały						

### Tkanina Atlas - IV grupa cenowa

 AS-531 - pomarańczowy	 AS-501 - różowy	 AS-651 - czerwony	 AS-681 - bordowy	 AS-391 - brązowy	 AS-781 - granatowy	 AS-161 - ciemny szary	 AS-111 - jasny szary
 AS-971 - jasny zielony	 AS-981 - ciemny zielony						

## Dane techniczne tkanin

Price group	Fabric	Material	Weight	Abrasion resistance rubs	Pilling resistance	Colour fastness to light	Colour fastness to rubbing	Flammability	More information
<b>I</b>	<b>NEMO</b>	Polyester 100%	366g/m2	PN-EN ISO 12947 - 2:2 100,000	Scale 1-8, max 8, PN-EN ISO 105 B02:2013 3-4	Scale 1-5, max 5, PN-EN 1021 - 2:2007, PN-EN 1021 - 1:2007	Scale 1-5, max 5, EN ISO 105x12, (wet/dry) 4-5		
<b>II</b>	<b>RUNNER</b>	Polyester 100%	320g/m2, 510g/lm	70,000 Martindale, BS EN 14465, EN ISO 12947-2	Scale 1-5, max 5, EN ISO 12945-2 4-5	Scale 1-8, max 8, EN ISO 105-B02 5-7	Scale 1-5, max 5, EN ISO 105x12, (wet/dry) 4-5	BS EN 1021-2 Match, BS EN 1021-1 Cigarette, California Bulletin CAL 117-E-Class 1, CA TB 117-2013, Class Uno UNI 9175 Class 1	Acoustic test sound absorption ISO 354
<b>II</b>	<b>MEDLEY</b>	Polyester 100%	364g/m2, 510g/lm	75,000 Martindale	Scale 1-5, max 5, EN ISO 12945-2 4	Scale 1-8, max 8, EN ISO 105-B02 5-7	Scale 1-5, max 5, EN ISO 105x12, (wet/dry) 4-5/4-5	BS EN 1021-2 Match, BS EN 1021-1 Cigarette, California Bulletin CAL 117-E-Class 1, CA TB 117-2013, Class Uno UNI 9175 Class 1	Acoustic test sound absorption: ISO 354
<b>II</b>	<b>ATLANTIC</b>	Polyester 100%	353g/m2, 530g/lm	110,000 Martindale, EN ISO 12947-2)		Scale 1-8, max 8, EN ISO 105-B02 5-7	Scale 1-5, max 5, EN ISO 105x12, (wet/dry) 4-5/4-5	BS EN 1021-2 Match, BS EN 1021-1 Cigarette, ASTM E 84, BS 476 Part 7, Class Uno UNI 9175 Class 1, NF P 92-503 M3P, CA TB 117-2013	
<b>II</b>	<b>VITA</b>	Surface: PVC, 98.5%, PU 1.5% Substrate: Polyester 50%, 50% Cotton	850g/m2, 1190g/lm	100,000 Martindale, EN ISO 5470-2:2003,		Scale 1-8, max 8, EN ISO 105-B02 5-7	Scale 1-5, max 5, EN ISO 105x12, (wet/dry) 4-5/4-5	BS EN 1021-2 Match, BS EN 1021-1 Cigarette, BS 5852:2006 Section 4, Ignition Source 5, BS 7176:2017 Medium Hazard NF P 95 503 M2, FMVSS 302 (ISO 3795)	Flexing cycles: BS EN ISO 7854:1997 Method B, 400,000, Anti-microbial/ Anti-fungal: AATCC 147:2011
<b>II</b>	<b>CHARLES</b>	Polyester 100%	433g/m2	90,000 Martindale, EN ISO 12947-2	Scale 1-5, max 5, EN ISO 12945-2 5	EN ISO 105-B02 5	Scale 1-5, max 5, EN ISO 105-X12, (wet/dry) 4-5	EN1021-2	Thread offset in the seam: EN ISO 13 936-2
<b>II</b>	<b>GO CHECK</b>	Trevira cs 100%	310g/m2	80,000 Martindale, EN ISO 12947-1,2 60,000 Double rubs wyzenbeek (ASTM D4157-07)	Scale 1-5, max 5, EN ISO 12945-2 5	Scale 1-8, max 8, EN ISO 105-B02 5-8	Scale 1-5, max 5, EN ISO 105-X12:2001, (wet/dry) 4-5/4-5	BS EN 1021-1&2 Cigarette and Match, BS 5852:2006 Crib 5, BS 7176:2017 Medium Hazard, NFP 92-503/504/505 M1, Class Uno UNI 9175 Class 1	
<b>II</b>	<b>MICA</b>	97% post-consumer recycled polyester / 3% polyester	218g/m2	60,000 Martindale, EN ISO 12947-2 100,000 Double rubs wyzenbeek (ASTM D4157-07)	Scale 1-5, max 5, EN ISO 12945-2 4-5	Scale 1-8, max 8, EN ISO 105-B02 5-8	Scale 1-5, max 5, EN ISO 105-X12:2001, (wet/dry) 4-5/4-5	BS EN 1021-1 Cigarette, BS EN 1021-2 Match, CA TB 117-2013, ASTM E 84 Class I, BS 476 Part 7 Class I	Acoustic test air flow resistance EN 29053 & ISO 9053-1 (airflow resistance)



## Dane techniczne tkanin

Price group	Fabric	Material	Weight	Abrasion resistance rubs	Pilling resistance	Colour fastness to light	Colour fastness to rubbing	Flammability	More information
III	<b>SYNERGY</b>	Virgin Wool 95%, Polyamide 5%	400g/m2 560g/lm	100,000 Martindale		ISO 105 B02: 5	Scale 1-5, max 5, EN ISO 105-X12:2001, (wet/dry) 4/4	BS EN 1021-1&2 Cigarette and Match, BS 7176 Low Hazard, UNI 9175 Classe 1 IM, B 3825 & A 3800-1	
III	<b>TESSA</b>	Poliester 95%, Akryl 5%	500g/m2	>75,000 Martindale ISO 12 497-2	Scale 1-5, max 5, EN ISO 12945-2 4-5	ISO 105 B02: 4	Scale 1-5, max 5, EN ISO 105-X12:2001, (wet/dry) 4-5/4-5		Thread offset in the seam: EN ISO 13 936-2
III	<b>OCEANIC</b>	100% post-consumer recycled polyester including 50% Seaqual Yarn	497g/m2	≥100,000 Martindale		5 (ISO 105 - B02), OOC16: 4/5 (ISO 105 - B02)	Scale 1-5, max 5, EN ISO 105-X12:2001, (wet/dry) 4-5/4-5	BS EN 1021-1&2 Cigarette and Match, BS 7176 Low Hazard, BS 5852 Ignition Source 5 with EnviroFlam5, BS 7176 Medium Hazard with EnviroFlam5	
III	<b>QUEST</b>	100% post-consumer recycled polyester including 75% Seaqual Yarn	330g/m2	≥100,000 Martindale		4-6 (ISO 105 - B02)	Scale 1-5, max 5, EN ISO 105-X12:2001, (wet/dry) 4/4	BS EN 1021-1&2 Cigarette and Match, BS 7176 Low Hazard, BS 5852 Ignition Source 5 with EnviroFlam5, BS 7176 Medium Hazard with EnviroFlam5, B 3825 & A 3800-1	
III	<b>GRAIN</b>	2287: 92% post-consumer recycled polyester / 8% polyester 2288: 80% post-consumer recycled polyester / 20% polyeste	439g/m2	100,000 Martindale (EN ISO 12947-2), double rubs wyzenbeek (ASTM D4157-07) (heavy duty upholstery) 100,000	Scale 1-5, max 5, EN ISO 12945-2 5	scale 1-8, max. 8 5-7 (ISO 105 - B02)	Scale 1-5, max 5, EN ISO 105-X12:2001, (wet/dry) 4-5/4-5	BS EN 1021-1&2 Cigarette and Match, CA TB 117-2013	
IV	<b>ATLAS</b>	New wool 90% Nylon 10%	286g/m2 400g/lm	100,000 Martindale EN ISO 12947	EN ISO 12945-2 4-5	ISO 105 B02: 6-7	ISO 105-X12:2001, (wet/dry) 4-5/4-5	BS EN 1021-2 Match, BS EN 1021-1 Cigarette, BS 5 5852 Crib 5, BS 5852 ignition source 3, BS 5852 Part 1, NF D 60 013, UNI 9175 1IM, US Cal, Bull. 117-2013, MED. CertificateIMO	
IV	<b>LEATHER</b>	Leather type - corrected grain leather Type of finishing - pigmented leather		Dry: 500 cycles - min. 4 grey scale Wet: 250 cycles - min. 4 grey scale UNI EN ISO 11640		Light fastness: min. 4 grey scale UNI ISO 105-802		Match flame test: No ignition UNI EN 1021-1-2006 BS EN 1021-1-2006	