

SPECYFIKACJA TECHNICZNA

KOLORYSTYKA

FRONT, BLAT GÓRNY, KORPUS, NOGA PODPIERAJĄCA NG41



67 BIAŁY PASTEL



117 BIAŁY

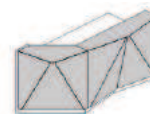
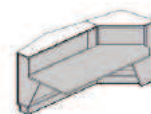

08 CZARNY

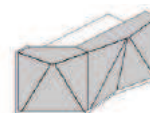
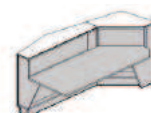

116 CZARNY

26 ALUMINIUM
SATINATO

124 SREBRNY

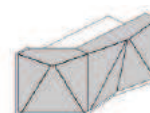
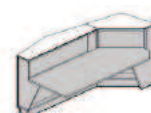
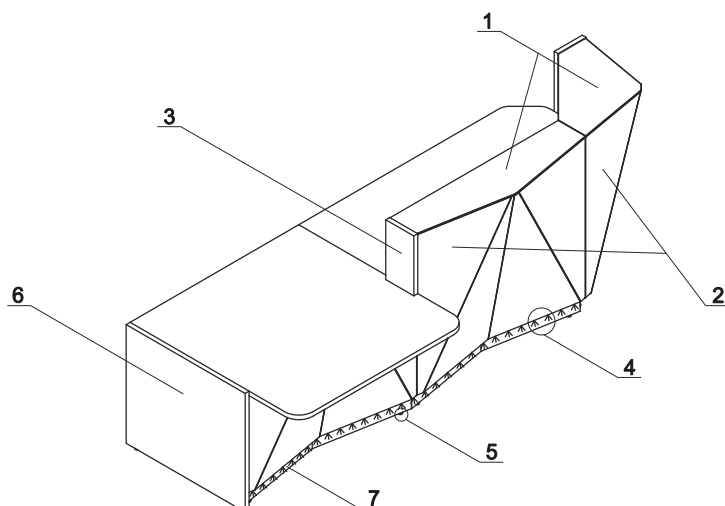
M009 ALUMINIUM
PÓŁMATM015 BIAŁY
PÓŁMATM115 CZARNY
PÓŁMAT

1. **Blat górny** - płyta melaminowana 28mm, szkło hartowane 8mm
2. **Front** - płyta melaminowana 12 mm + szkło LACOBEL 4mm
3. **Bok łączący lady niskie i wysokie** - płyta melaminowana 28mm, obrzeża PVC
4. **Oświetlenie LED** - na całej długości lady, barwa biała-zimna (wpada lekko w odcień niebieski)
5. **Regulator poziomy** - regulacja w zakresie 5mm
6. **Noga boczna niska** - płyta melaminowana 28mm, obrzeża PVC
7. **Cokół** - HPL - aluminium szczotkowane

SPECYFIKACJA TECHNICZNA

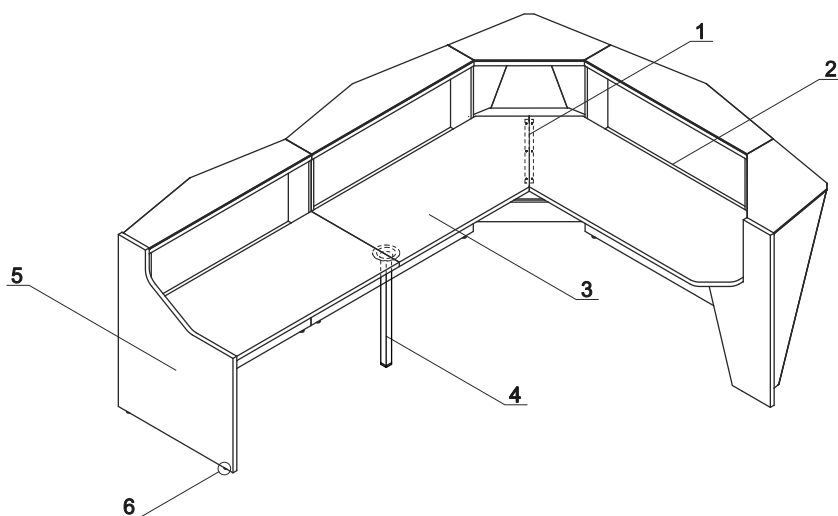

1. **Płaskownik mocujący**
2. **Półka pod monitor** - płyta melaminowana 28mm
3. **Błat roboczy** - płyta melaminowana 28mm, obrzeża PVC
4. **Noga podpierająca NG41** - metal malowany proszkowo, wymagana na łączeniu blatów
5. **Noga boczna wysoka** - płyta melaminowana 28mm, obrzeża PVC
6. **Regulator poziomu** - regulacja w zakresie 5mm

ZASTOSOWANIE ELEMENTÓW KOŃCĄCYCH

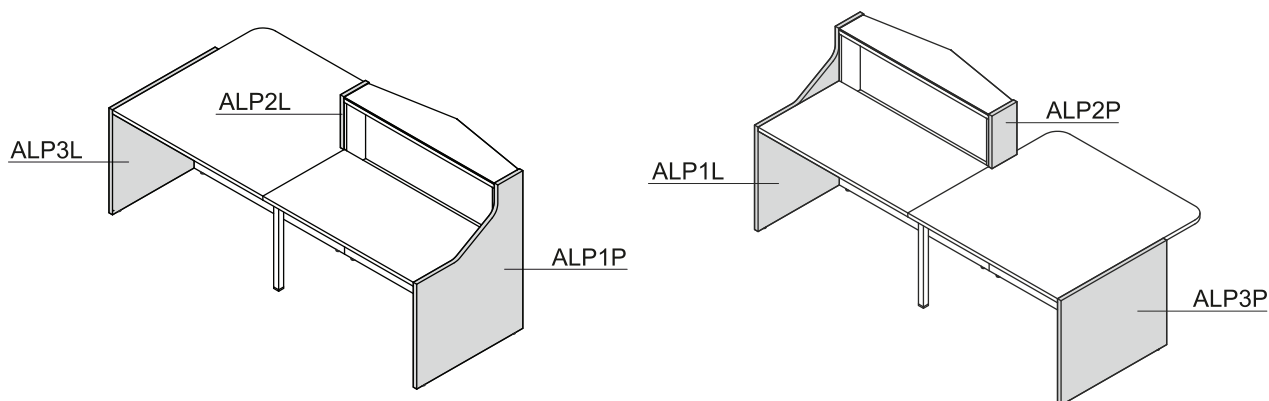

WYMIARY

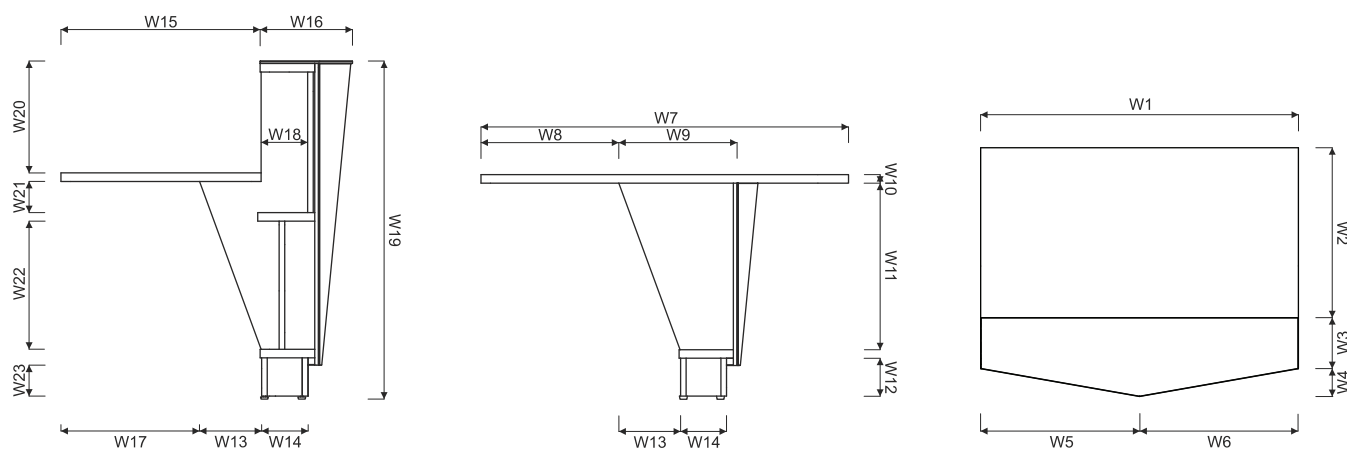

W1 - 1199mm | W2 - 650mm | W3 - 194mm | W4 - 106mm | W5 - 608mm | W6 - 608mm | W7 - 1200mm | W8 - 448mm | W9 - 353mm | W10 - 28mm |
 W11 - 549mm | W12 - 125mm | W13 - 199mm | W14 - 150mm | W15 - 650mm | W16 - 300mm | W17 - 449mm | W18 - 151mm | W19 - 1106mm |
 W20 - 366mm | W21 - 102mm | W22 - 424mm | W23 - 125mm

UKŁADY LAD

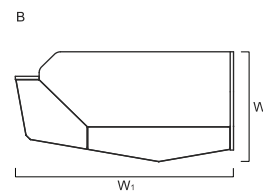
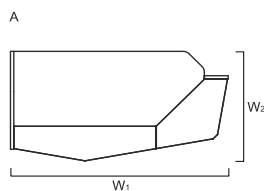
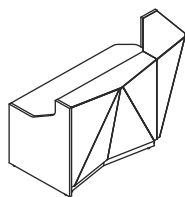

SYMBOL	WYMIARY [mm]					CENA NETTO PLN				ELEMENTY SKŁADOWE
	W ₁	W ₂	D ₁	D ₂	H					
A ALP04L	1835	946	-	-	1100	9 285,-	103.0	1.047	7	ALP18L+ALP1P
B ALP04P	1835	946	-	-	1100	9 285,-	103.0	1.047	7	ALP1L+ALP18P

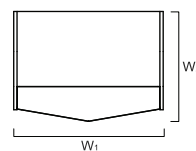
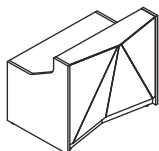

SYMBOL	WYMIARY [mm]					CENA NETTO PLN				ELEMENTY SKŁADOWE
	W ₁	W ₂	D ₁	D ₂	H					
ALP05	1256	946	-	-	1100	5 285,-	76.5	0.782	5	ALP1L+ALP12+ALP1P

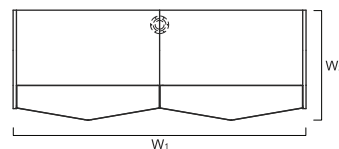
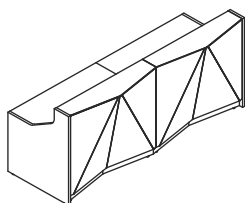

SYMBOL	WYMIARY [mm]					CENA NETTO PLN				ELEMENTY SKŁADOWE
	W ₁	W ₂	D ₁	D ₂	H					
ALP06	2456	946	-	-	1100	9 995,-	129.0	1.498	9	ALP1L+2xALP12+ALP1P+NG41

LEGENDA:

- WAGA NETTO

- OBJĘTOŚĆ

- ILOŚĆ PACZEK

UKŁADY LAD

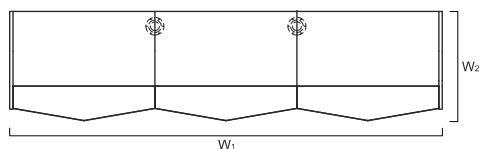
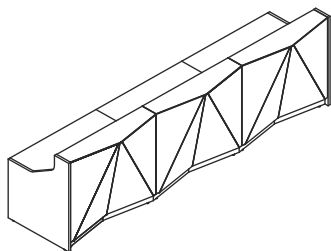

SYMBOL	WYMIARY [mm]					CENA NETTO PLN				ELEMENTY SKŁADOWE
	W ₁	W ₂	D ₁	D ₂	H					
ALP07	3656	946	-	-	1100	14 710,-	181.5	2.214	13	ALP1L+3xALP12+ALP1P+2xNG41

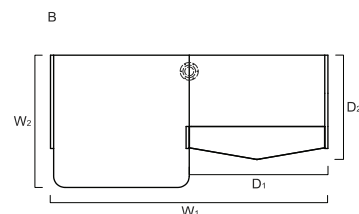
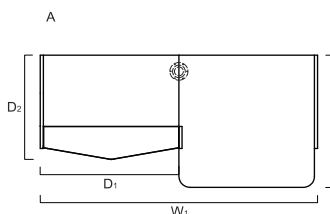
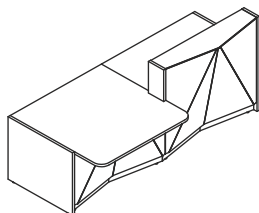

SYMBOL	WYMIARY [mm]					CENA NETTO PLN				ELEMENTY SKŁADOWE
	W ₁	W ₂	D ₁	D ₂	H					
A ALP21L	2456	1200	1228	950	1100	9 560,-	135.0	1.264	9	ALP3L+ALP11+ALP2P+ALP12+ALP1P+NG41
B ALP21P	2456	1200	1228	950	1100	9 560,-	135.0	1.264	9	ALP1L+ALP12+ALP2L+ALP11+ALP3P+NG41

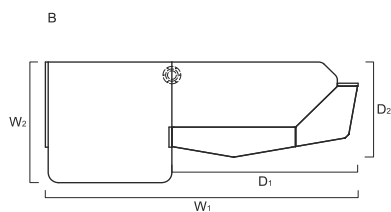
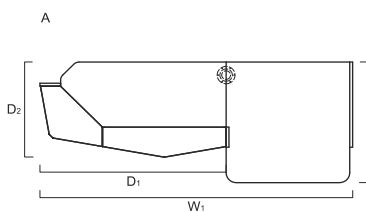
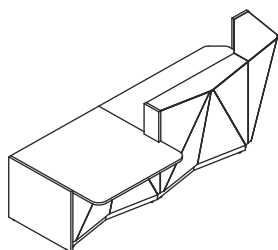

SYMBOL	WYMIARY [mm]					CENA NETTO PLN				ELEMENTY SKŁADOWE
	W ₁	W ₂	D ₁	D ₂	H					
A ALP22L	3034	1200	1806	950	1100	13 560,-	163.0	1.533	12	ALP3L+ALP11+ALP2P+ALP18P+NG41
B ALP22P	3034	1200	1806	950	1100	13 560,-	163.0	1.533	12	ALP18L+ALP2L+ALP11+ALP3P+NG41

LEGENDA:

- WAGA NETTO

- OBJĘTOŚĆ

- ILOŚĆ PACZEK

UKŁADY LAD

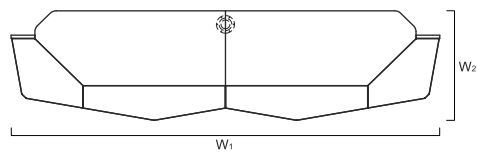
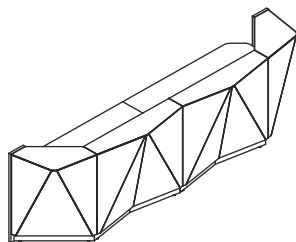

SYMBOL	WYMIARY [mm]					CENA NETTO PLN				ELEMENTY SKŁADOWE
	W ₁	W ₂	D ₁	D ₂	H		kg	m ³	szt	
ALP15	3613	946	-	-	1100	18 000,-	182.0	2.029	13	ALP18L+ALP18P+NG41

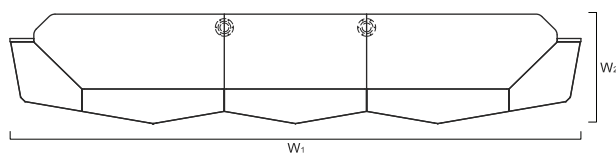
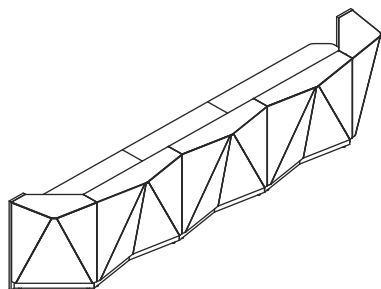

SYMBOL	WYMIARY [mm]					CENA NETTO PLN				ELEMENTY SKŁADOWE
	W ₁	W ₂	D ₁	D ₂	H		kg	m ³	szt	
ALP16	4813	946	-	-	1100	22 710,-	234.5	2.745	17	ALP18L+ALP12+ALP18P+2xNG41

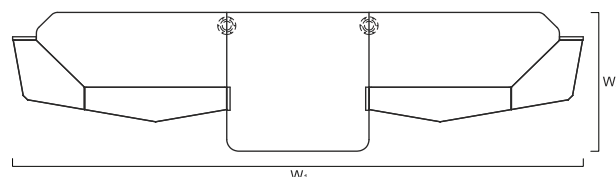
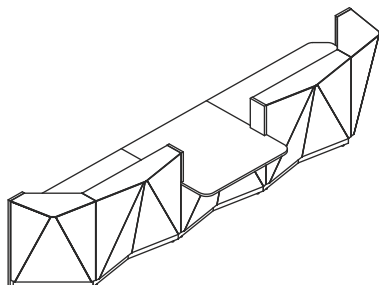

SYMBOL	WYMIARY [mm]					CENA NETTO PLN				ELEMENTY SKŁADOWE
	W ₁	W ₂	D ₁	D ₂	H		kg	m ³	szt	
ALP25	4813	1200	-	-	1100	22 505,-	244.5	2.530	19	ALP18L+ALP2L+ALP11+ALP2P+ALP18P+2xNG41

LEGENDA:

- WAGA NETTO

- OBJĘTOŚĆ

- ILOŚĆ PACZEK

UKŁADY LAD

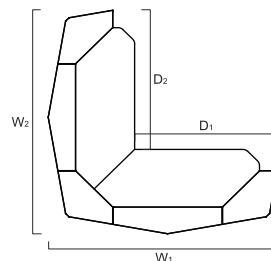
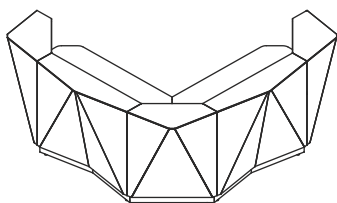

SYMBOL	WYMIARY [mm]					CENA NETTO PLN				ELEMENTY SKŁADOWE
	W ₁	W ₂	D ₁	D ₂	H					
ALP14	2514	2514	1568	1568	1100	22 250,-	210.5	2.307	14	

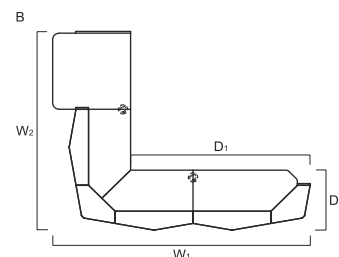
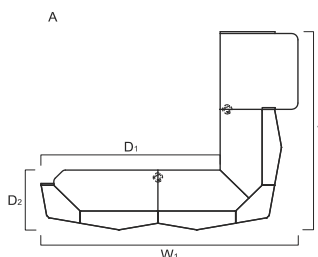
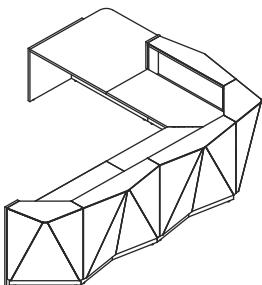

SYMBOL	WYMIARY [mm]					CENA NETTO PLN				ELEMENTY SKŁADOWE
	W ₁	W ₂	D ₁	D ₂	H					
A ALP24L	3967	3135	2768	950	1100	27 235,-	299.5	3.243	21	ALP3L+ALP11+ALP2P+ALP90+ALP18P+2xNG41
B ALP24P	3967	3135	2768	950	1100	27 235,-	299.5	3.243	21	ALP18L+ALP90+ALP2L+ALP11+ALP3P+2xNG41

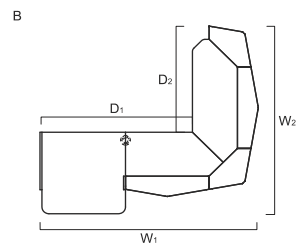
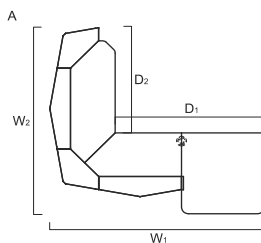
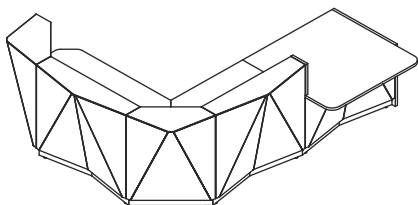

SYMBOL	WYMIARY [mm]					CENA NETTO PLN				ELEMENTY SKŁADOWE
	W ₁	W ₂	D ₁	D ₂	H					
A ALP23L	3135	2767	2189	1568	1100	22 520,-	245.5	2.527	17	ALP3L+ALP11+ALP2P+ALP19P+NG41
B ALP23P	3135	2767	2189	1568	1100	22 520,-	245.5	2.527	17	ALP19L+ALP2L+ALP11+ALP3P+NG41

LEGENDA:

- WAGA NETTO

- OBJĘTOŚĆ

- ILOŚĆ PACZEK

UKŁADY LAD

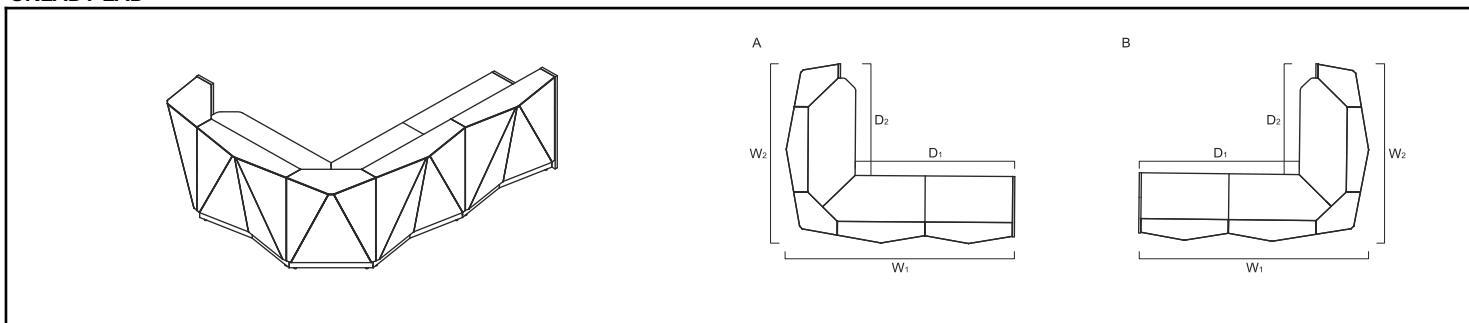

SYMBOL	WYMIARY [mm]					CENA NETTO PLN				ELEMENTY SKŁADOWE
	W ₁	W ₂	D ₁	D ₂	H					
A ALP17L	3135	2514	2189	1568	1100	22 960,-	238.0	2.757	16	ALP19L+ALP12+ALP1P+NG41
B ALP17P	3135	2514	2189	1568	1100	22 960,-	238.0	2.757	16	ALP1L+ALP12+ALP19P+NG41

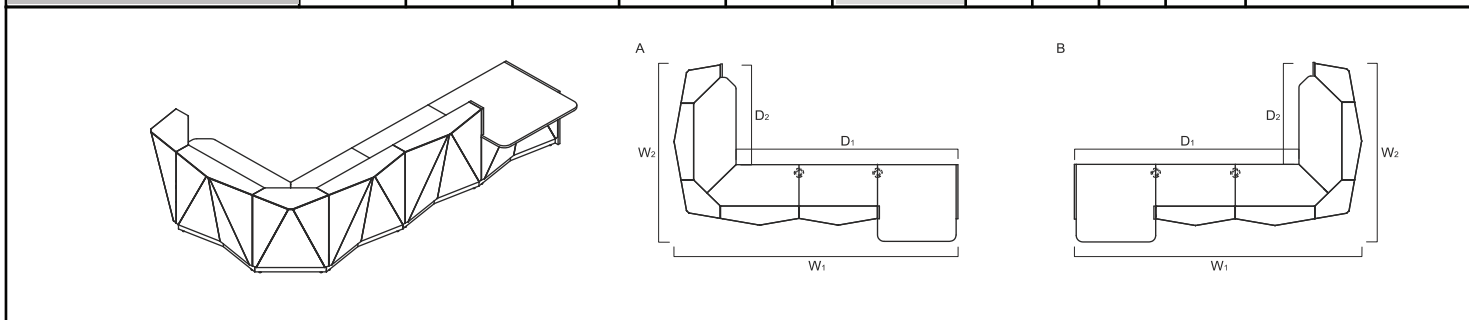

SYMBOL	WYMIARY [mm]					CENA NETTO PLN				ELEMENTY SKŁADOWE
	W ₁	W ₂	D ₁	D ₂	H					
A ALP26L	4335	2767	3390	1568	1100	27 235,-	298.0	3.243	21	ALP3L+ALP11+ALP2P+ALP12+ALP19P+2xNG41
B ALP26P	4335	2767	3390	1568	1100	27 235,-	298.0	3.243	21	ALP19L+ALP12+ALP2L+ALP11+ALP3P+2xNG41

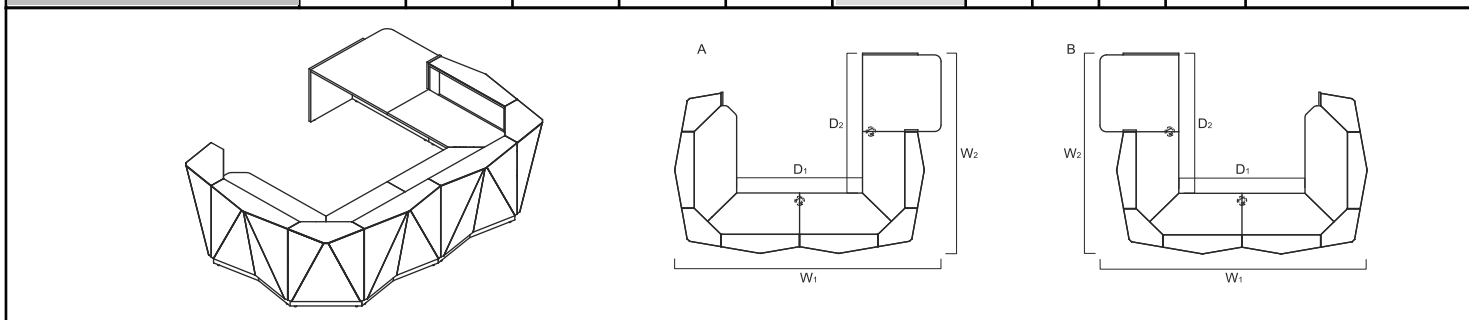



SYMBOL	WYMIARY [mm]					CENA NETTO PLN				ELEMENTY SKŁADOWE
	W ₁	W ₂	D ₁	D ₂	H					
A ALP27L	4069	3135	1922	2189	1100	36 195,-	382.0	4.237	26	ALP3L+ALP11+ALP2P+ALP90+ALP19P+2xNG41
B ALP27P	4069	3135	1922	2189	1100	36 195,-	382.0	4.237	26	ALP19L+ALP90+ALP2L+ALP11+ALP3P+2xNG41

LEGENDA:



- WAGA NETTO

- OBJĘTOŚĆ



- ILOŚĆ PACZEK

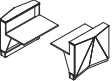
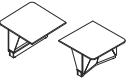
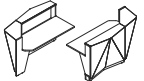

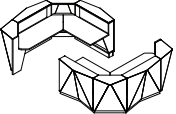
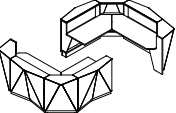
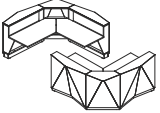
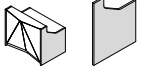
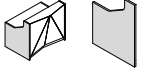
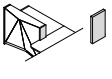
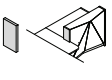
WIDOK I RZUT OBIEKTU	WYMIARY [mm]			SYMBOL	CENA NETTO PLN				UWAGI
	SZEROKOŚĆ	GŁĘBOKOŚĆ	WYSOKOŚĆ			kg	m3	szt	

ELEMENTY SKŁADOWE



	1200	946	1100	ALP12	4 635,-	50.5	0.714	3	
	1200	1200	740	ALP11	4 225,-	57.5	0.490	3	
	1806	946	1100	ALP18L	8 960,-	90.0	1.013	6	
	1806	946	1100	ALP18P	8 960,-	90.0	1.013	6	
	2514	1907	1100	ALP19L	17 920,-	172.5	2.007	11	
	2514	1907	1100	ALP19P	17 920,-	172.5	2.007	11	
	1907	1907	1100	ALP90	13 595,-	133.5	1.703	6	
	846	28	1100	ALP1L	325,-	13.0	0.034	1	bok lady wysokiej - lewy
	846	28	1100	ALP1P	325,-	13.0	0.034	1	bok lady wysokiej - prawy
	200	28	368	ALP2L	105,-	1.5	0.004	1	bok do łączenia lady niskiej i wysokiej, lewy
	200	28	368	ALP2P	105,-	1.5	0.004	1	bok do łączenia lady niskiej i wysokiej, prawy

LEGENDA:

 - WAGA NETTO - OBJĘTOŚĆ - ILOŚĆ PACZEK

WIDOK I RZUT OBIEKTU	WYMIARY [mm]			SYMBOL	CENA NETTO PLN				UWAGI
	SZEROKOŚĆ	GŁĘBOKOŚĆ	WYSOKOŚĆ			kg	m3	szt	

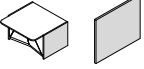
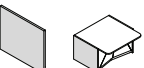
ELEMENTY SKŁADOWE

	846	28	730	ALP3L	195,-	12.0	0.024	1	noga do lady niskiej, lewa
	846	28	730	ALP3P	195,-	12.0	0.024	1	noga do lady niskiej, prawa
	40	40	712	NG41	77,-	2.0	0.002	1	noga kwadratowa

LEGENDA:

 - WAGA NETTO - OBJĘTOŚĆ - ILOŚĆ PACZEK