

Zestawienie kolorystyczne - Ovo

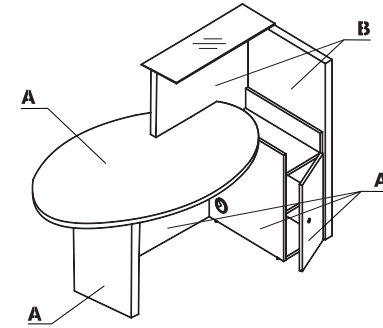
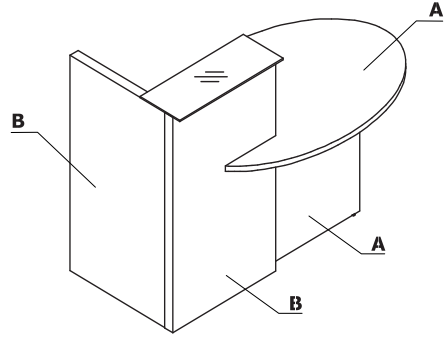

Material	Kolor	Wszystkie elementy systemu															
		A - Korpus	B - Front														
Płyta	67 - biały pastel	✓															
	64 - kakao		✓														
	171 - orzech ciemny		✓														

Opis techniczny

- 1 Błat górny** - szkło hartowane, satynowane 8 mm
- 2 Front** - płyta melaminowana 52 mm
- 3 Błat roboczy** - płyta melaminowana 28 mm, obrzeża ABS
- 4 Korpus** - płyta melaminowana 28 mm, obrzeża ABS
- 5 Korpus** - płyta melaminowana 18 mm, obrzeża ABS
- 6 Regulator poziomu** - regulacja w zakresie 5 mm
- 7 Przepust kablówy prostokątny** - wymiary otworu 90x48 mm
- 8 Regał wewnętrzny** - płyta melaminowana 18 mm, obrzeża ABS
- 9 Zamek patentowy**
- 10 Front** - płyta melaminowana 18 mm, obrzeża ABS
- 11 Przepusty kablówy** - $\varnothing 80$ mm

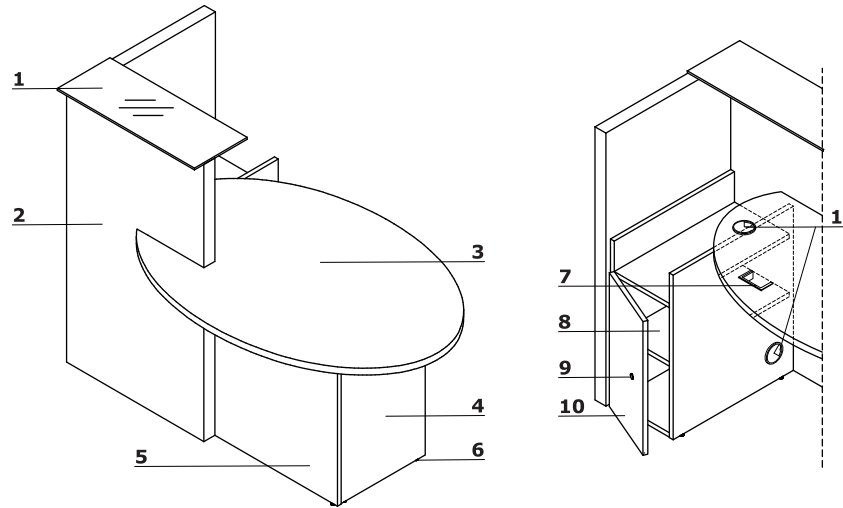

Wymiary (mm)

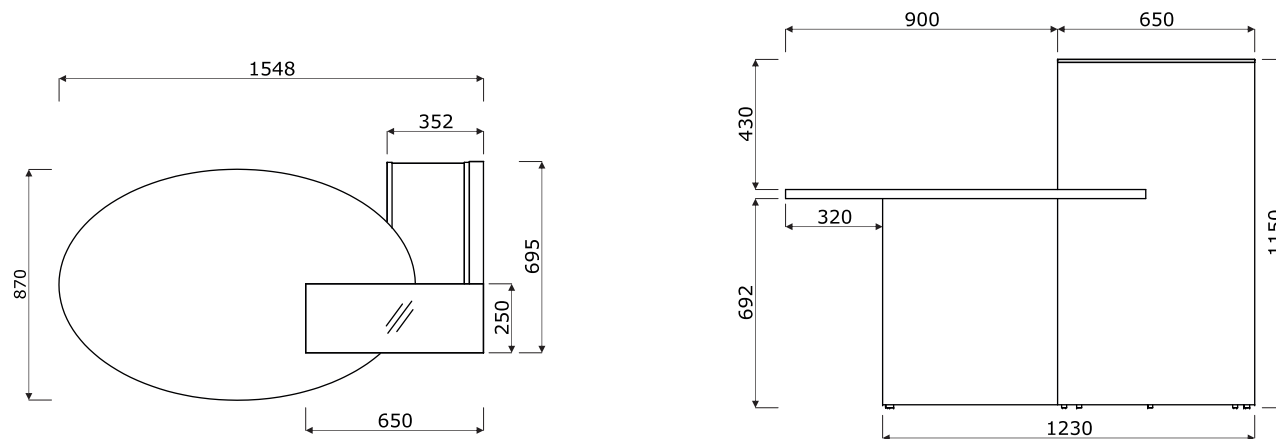

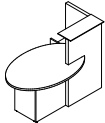
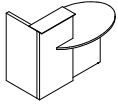

Lada Ovo							
	Symbol	Cena netto PLN	Wymiary			Waga Obj. Opak.	Uwagi
			Szer.	Gł.	Wys.		
	LOP10	3000,-	1550	870	1150	100.65 kg 0.24 m ³ 3 szt.	
	LOL10	3000,-	1550	870	1150	99.8 kg 0.236 m ³ 3 szt.	

Dodatkowa dopłata							





Płyta

 08 - czarny	 26 - aluminium satinato	 31 - dąb kanadyjski	 64 - kakao	 67 - biały pastel	 106 - orzech nizinny	 167 - dąb szary	 168 - dąb naturalny
 169 - dąb miodowy	 170 - akacja	 172 - dąb bursztynowy	 173 - robinia				



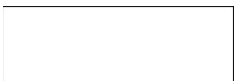







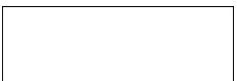
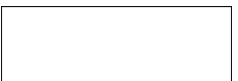

Metal

 M009 - aluminium półmat RAL 9006	 M015 - biały półmat RAL 9010	 M115 - czarny półmat RAL 9005
--	--	---

Szkło

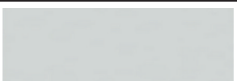
 116 - szkło czarne - RAL 9005	 117 - szkło białe - RAL 9003	 124 - szkło srebrne - RAL 9007	 134 - szkło turkusowe - NCS S 4050B20G	 135 - szkło żółte - RAL DESIGN 0908080	 136 - szkło różowe - RAL DESIGN 3404045
---	---	--	---	--	---

HPL

 26 - aluminium satinato	 31 - dąb kanadyjski	 67 - biały pastel	 73 - biały połysk	 101 - czarny połysk	 148 - szary połysk	 155 - antracyt połysk	 174 - beżowy mat
 175 - truflowy mat	 176 - czerwony mat	 177 - szary mat	 178 - avocado mat	 179 - zielony butelkowy mat	 180 - błękitny pruski mat	 184 - błękitny mat	